

Montageanleitung

Gartenhäuser



www.weka-holzbau.com

DE

**GEBRAUCHS- UND
WARTUNGSANLEITUNG**



T2-20.02

Stand: 2117

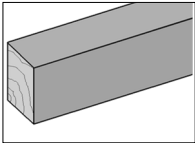
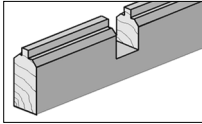
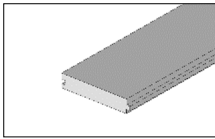
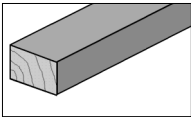
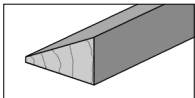
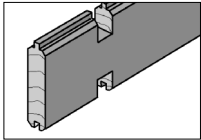
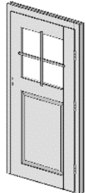
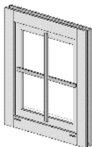

Pos	Bild	Abmessung	Bemerkung
①		50 / 70	
②		21 / 63 28 / 63 45 / 63	21mm WS 28 mm WS 45 mm WS
③		19,5 / 121	
④		15 / 25	
⑤		28 / 45	
⑥		21 / 121 28 / 121 45 / 121	21 mm WS 28 mm WS 45 mm WS
⑦			
⑧			

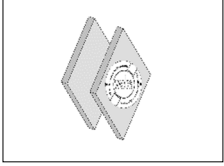
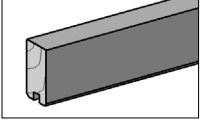
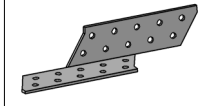
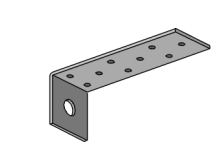
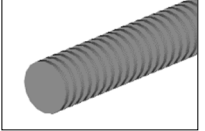
Pos	Bild	Abmessung	Bemerkung
9		11 / 58	
10			
11			
12		45 / 146	
13		19,5 / 121	
14		18,5 / 96	
15		18,5 / 146	
16		18,5 / 58	

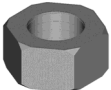
Pos	Bild	Abmessung	Bemerkung
17		18,5 / 160 / 260	
18	-	-	-
19			
20			
21		40 / 40 / 140	
22		M8	
23			
24		M8	

Pos	Bild	Abmessung	Bemerkung
25			
26		5,0 x 120	
27		5,0 x 80	
28		4,0 x 40	
29		3,5 x 35	
30		5,0 x 20	21 mm WS 28 mm WS 45 mm WS
31		22 x 55	
32	-	-	-

Pos	Bild	Abmessung	Bemerkung
33			
34		16 x 30	

Dachmontage

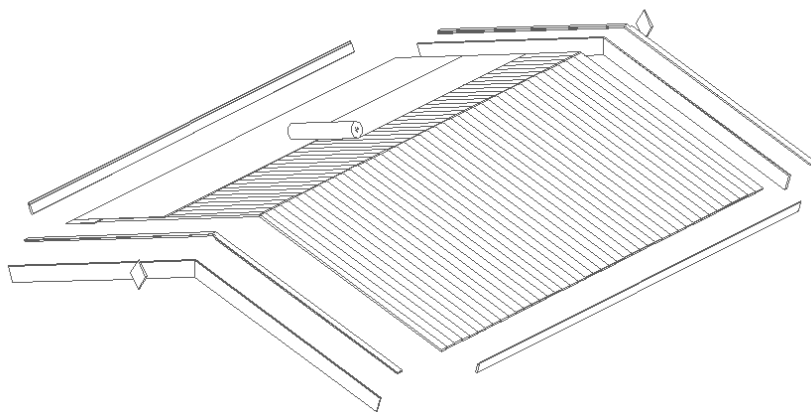

Giebelmontage



Wandmontage



Fußbodenmontage

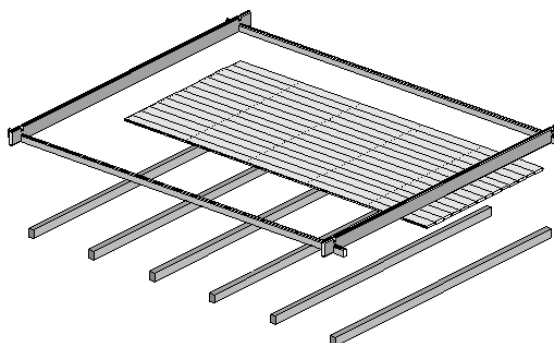

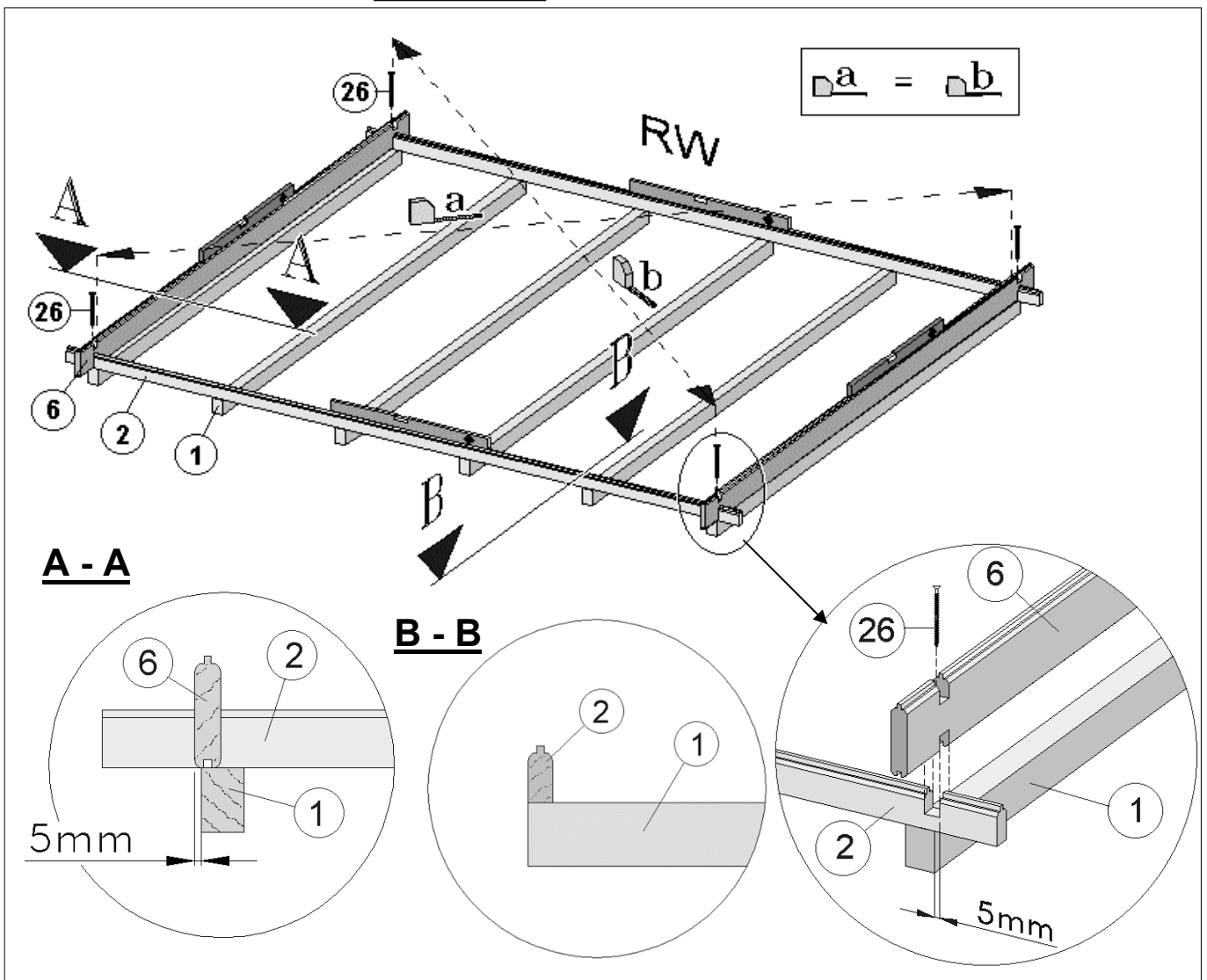

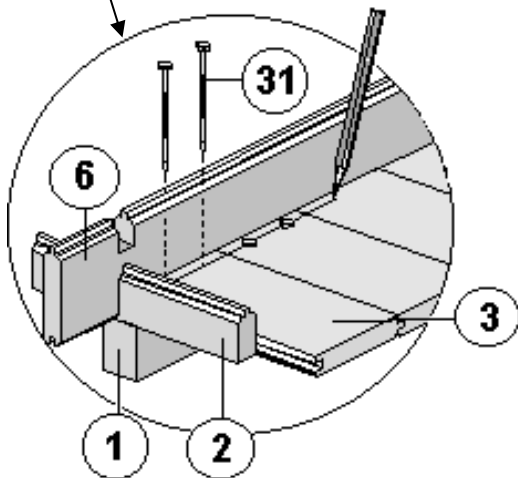
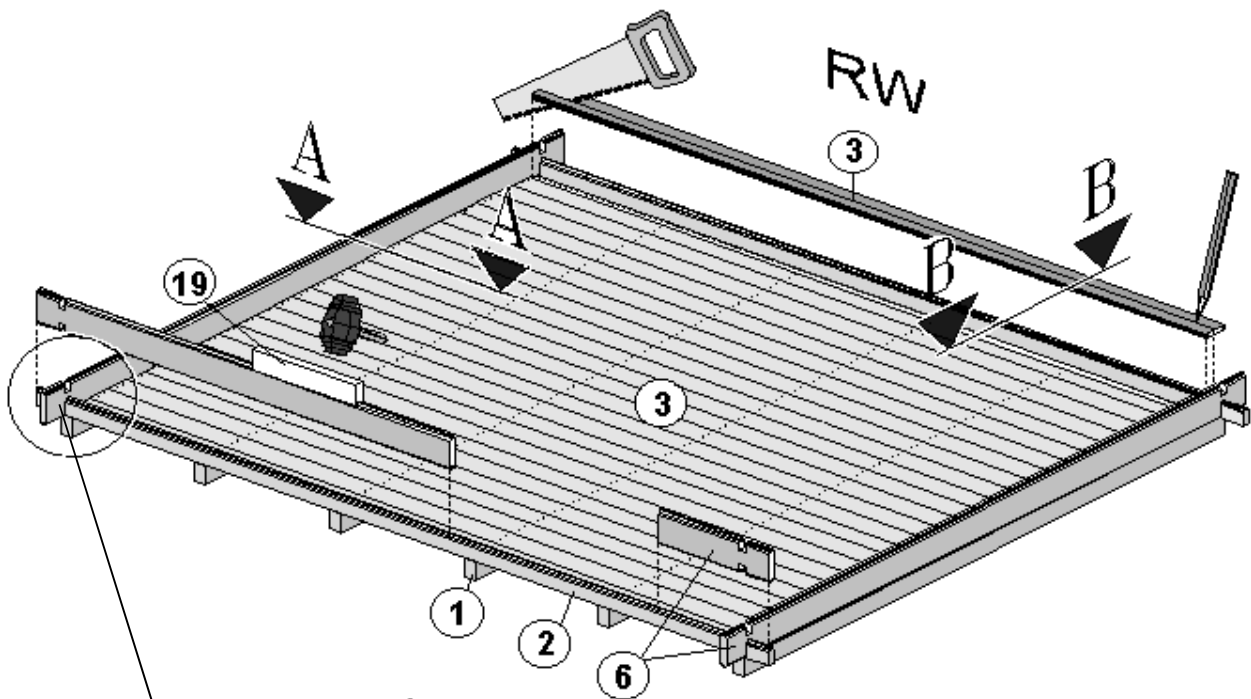
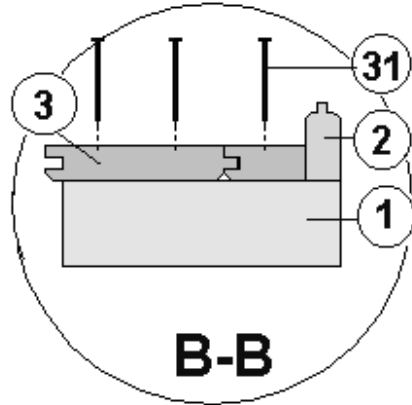
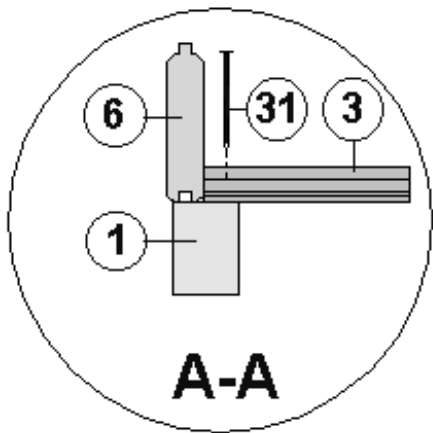
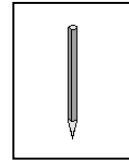
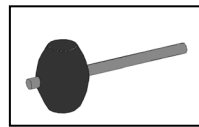
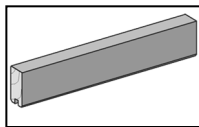
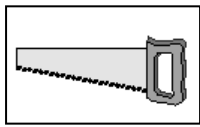

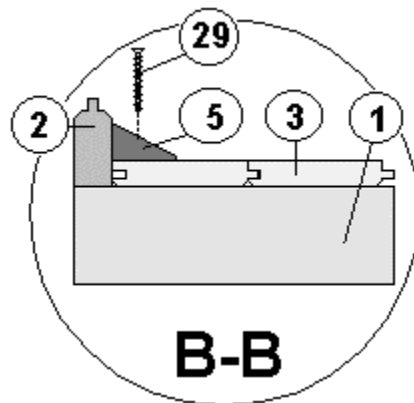
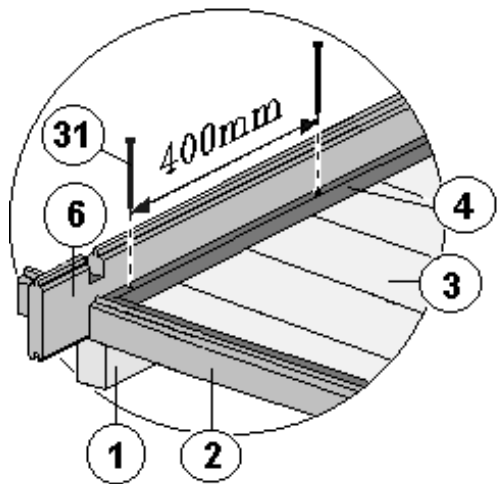
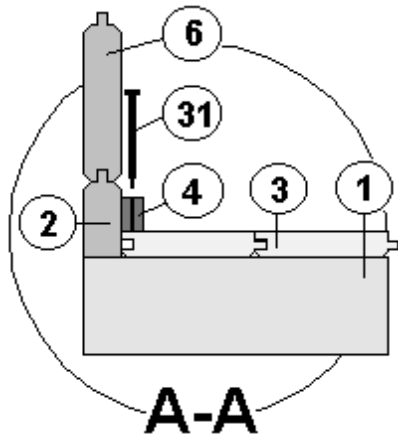
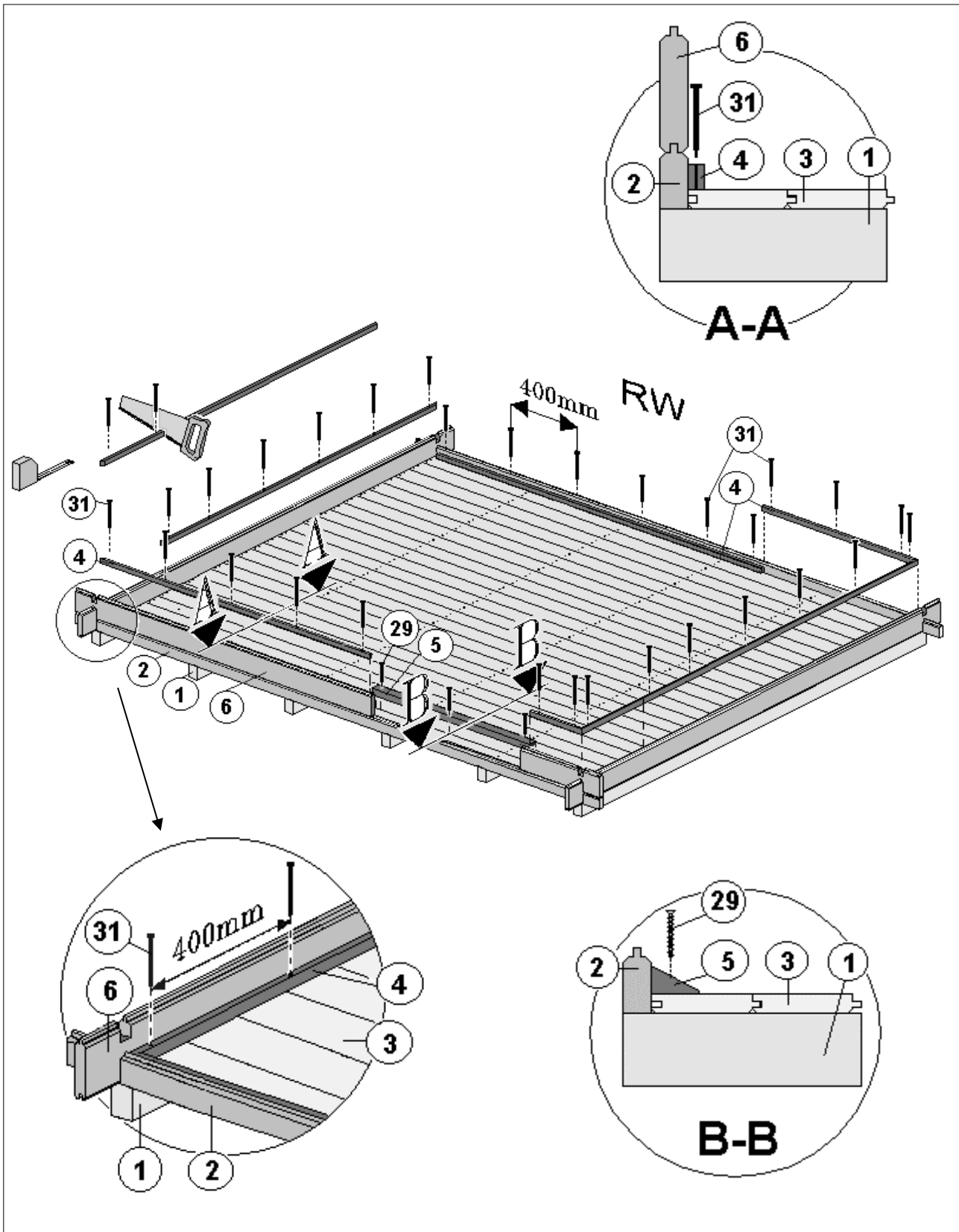
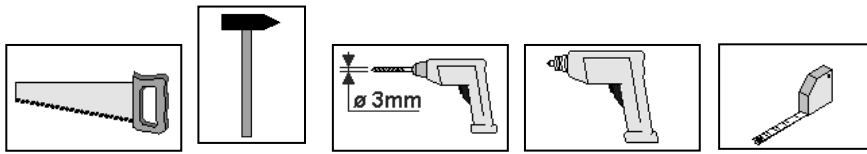

Dachmontage

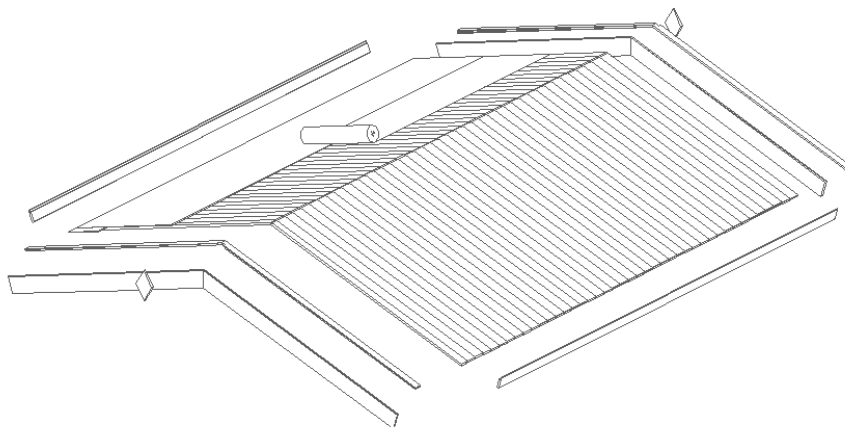

Giebelmontage

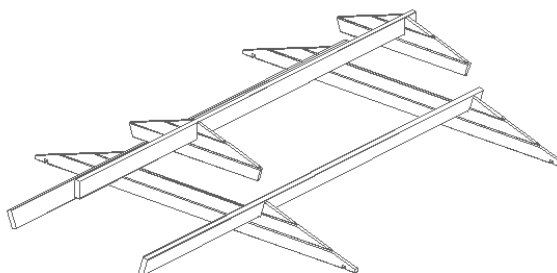

Wandmontage

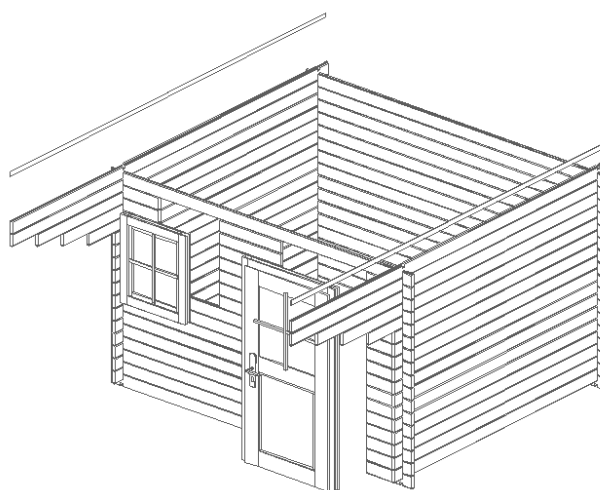

Fußbodenmontage

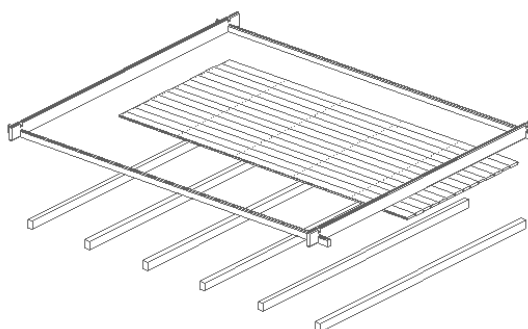

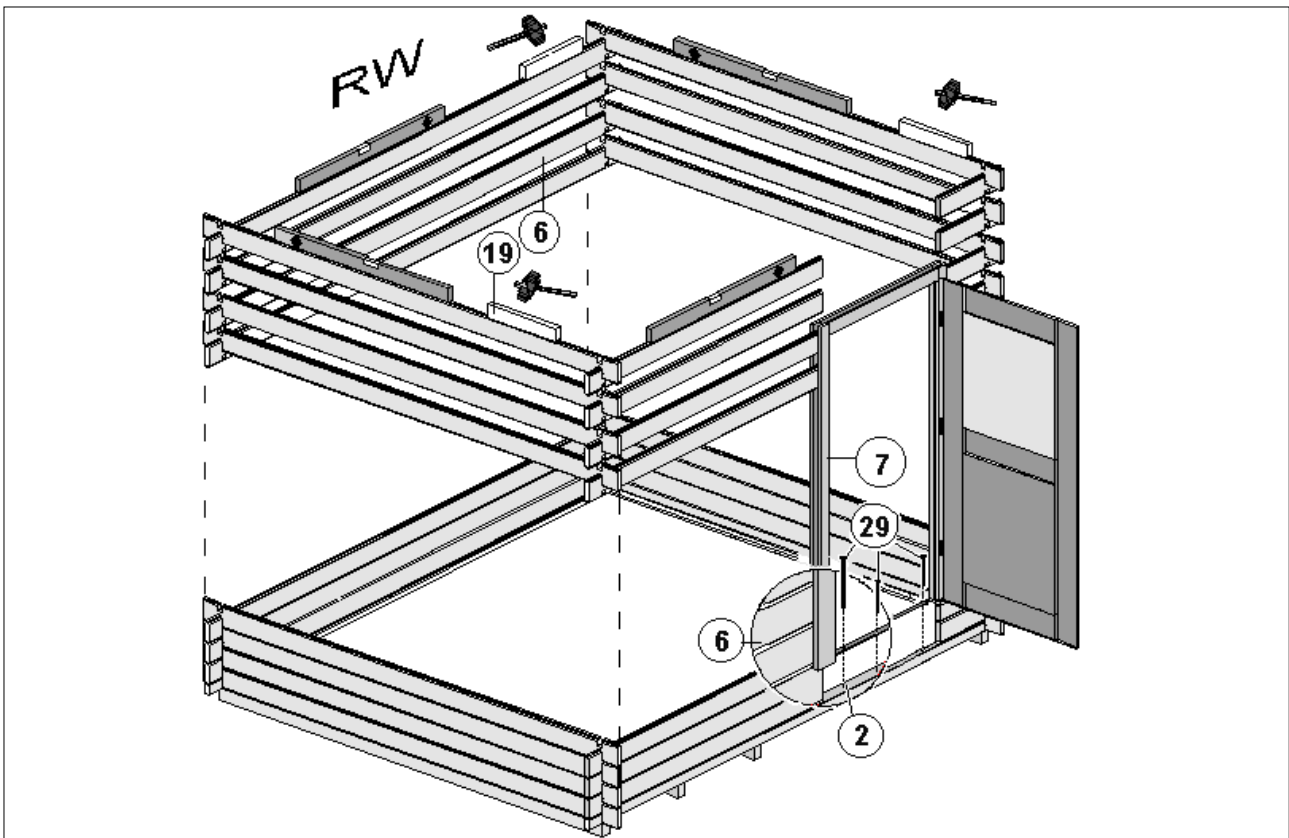
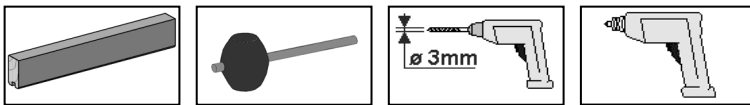
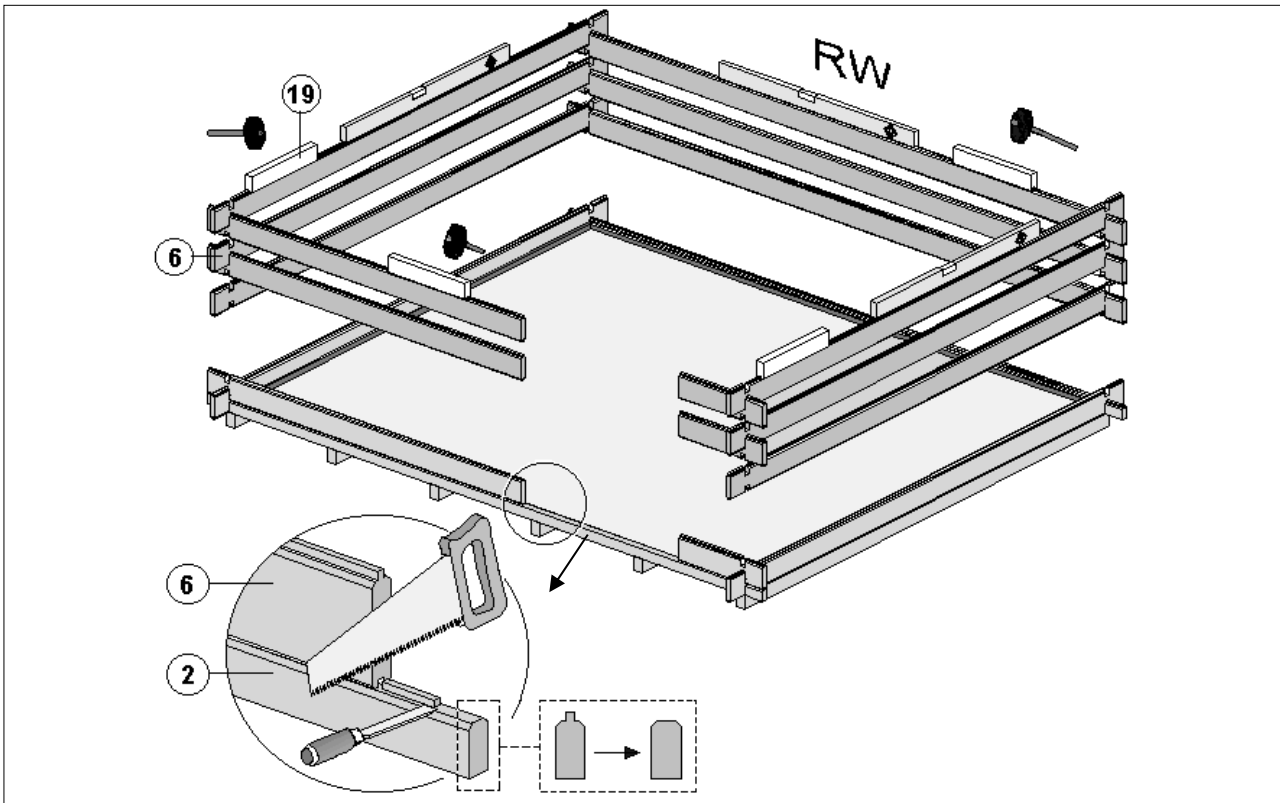
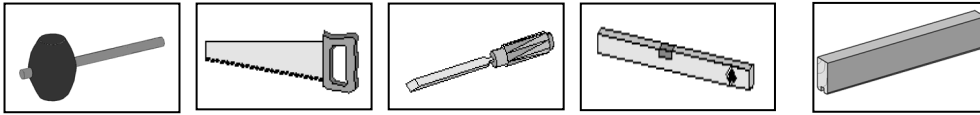

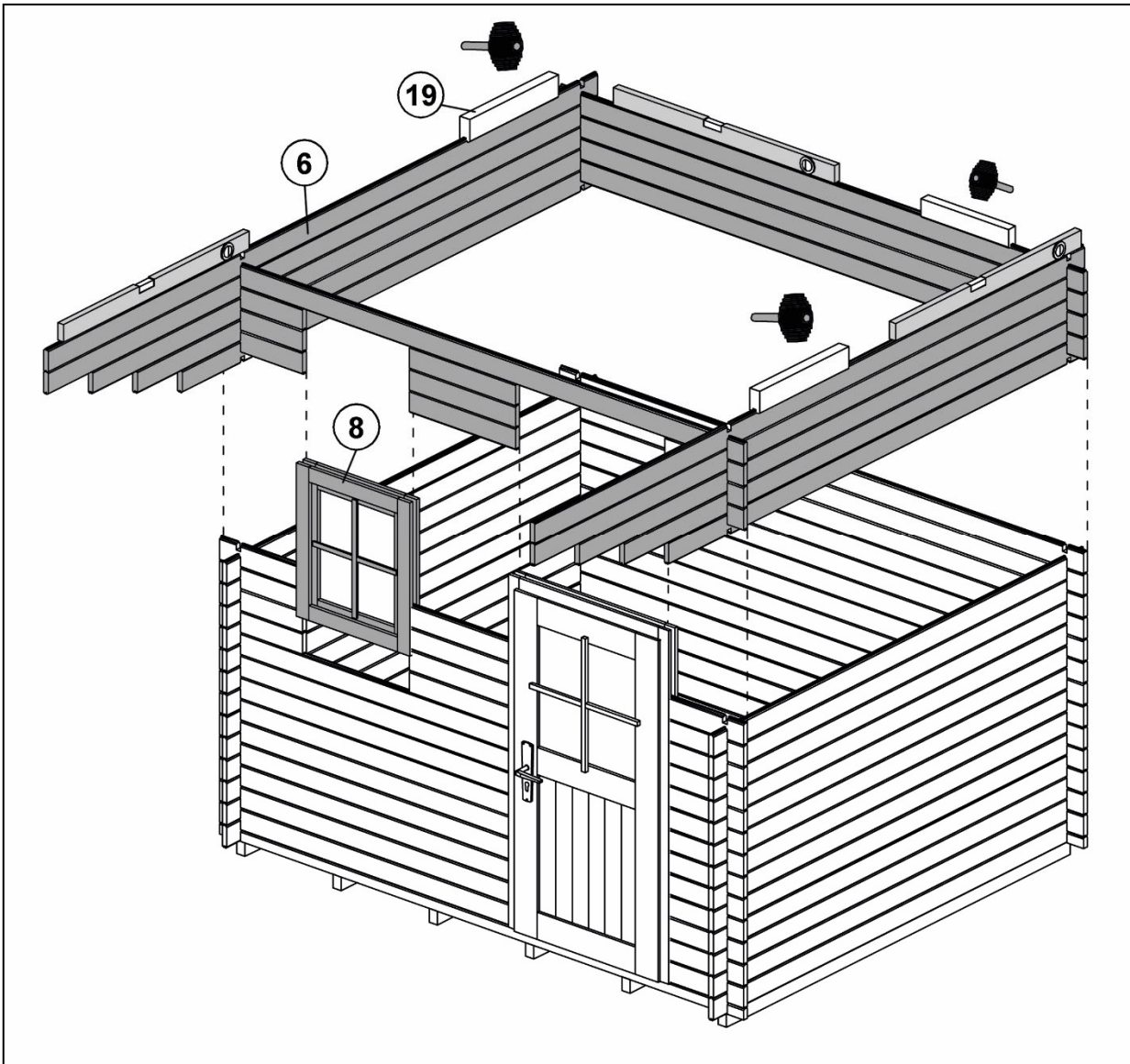
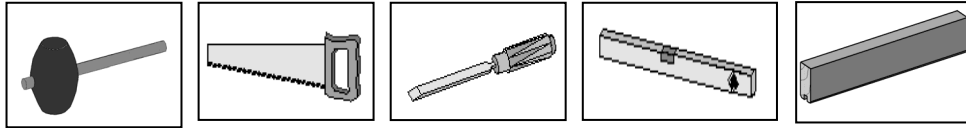

Dachmontage



Giebelmontage



Wandmontage



Fußbodenmontage



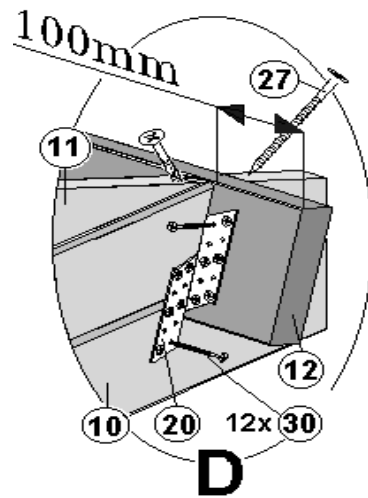

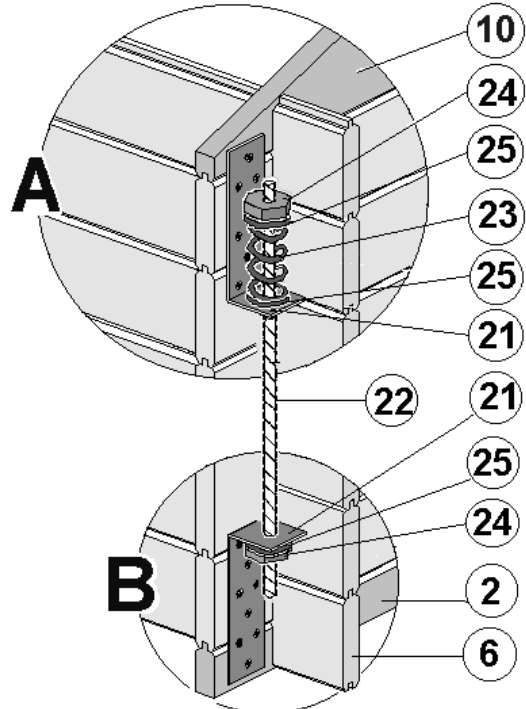
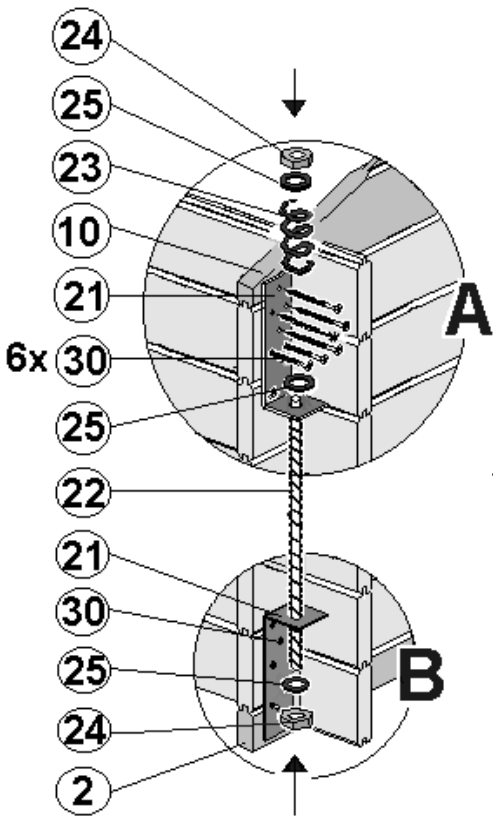

Dachmontage

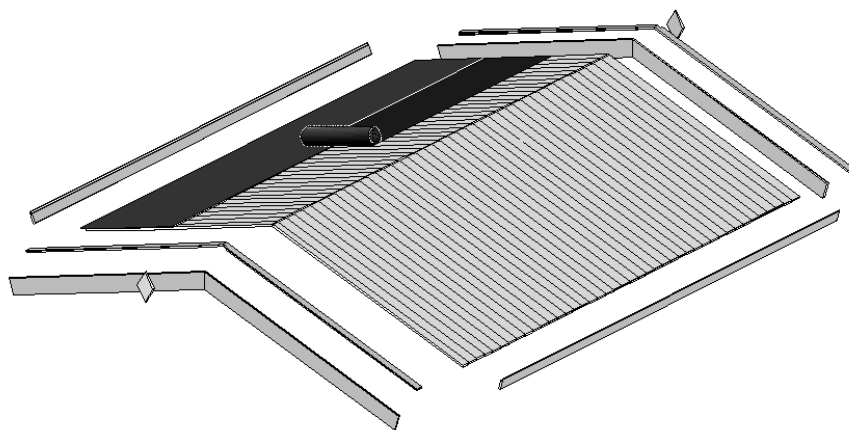

Giebelmontage

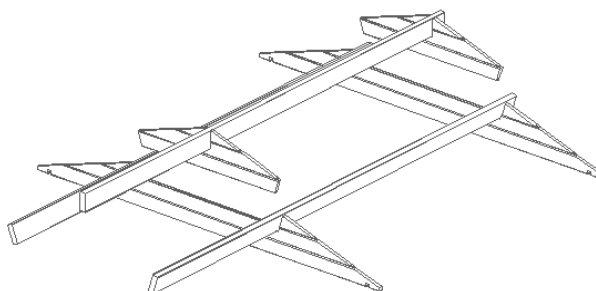

Wandmontage

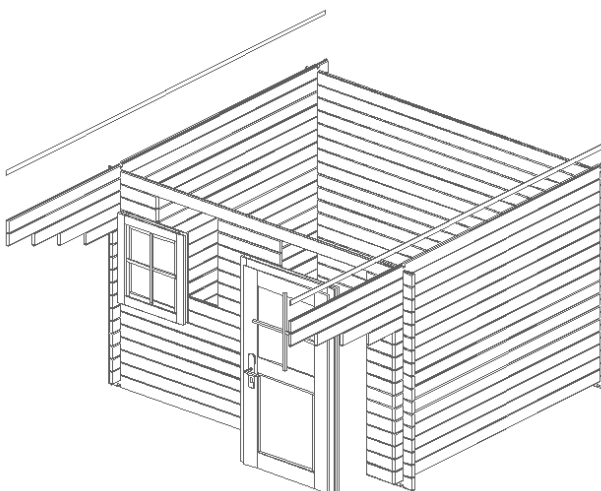

Fußbodenmontage



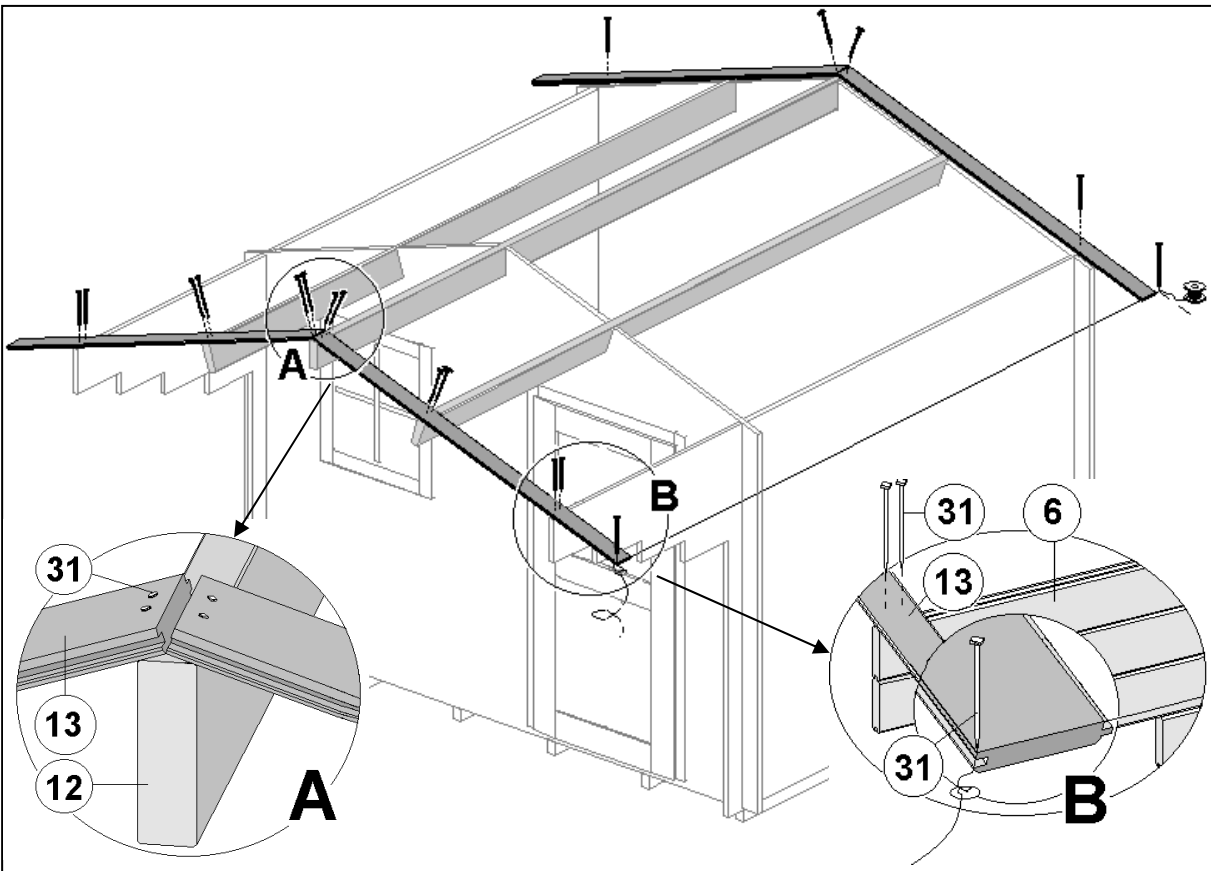
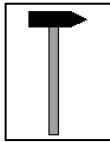
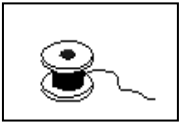





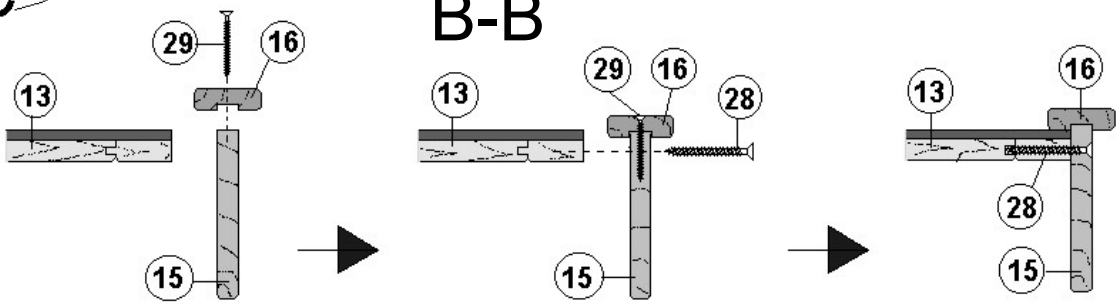
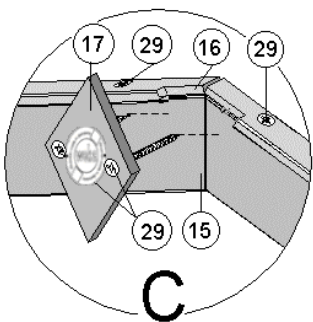
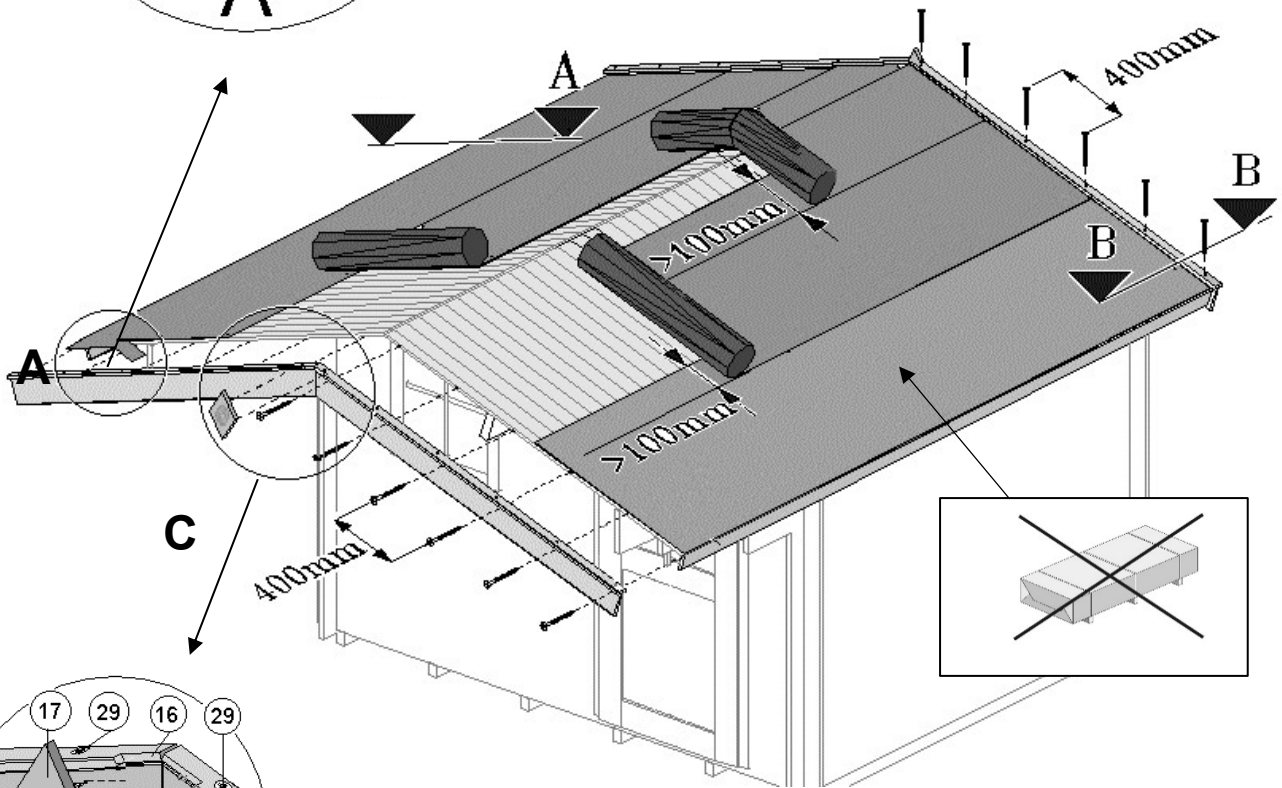
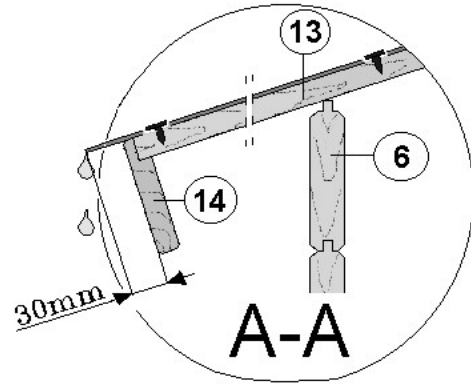
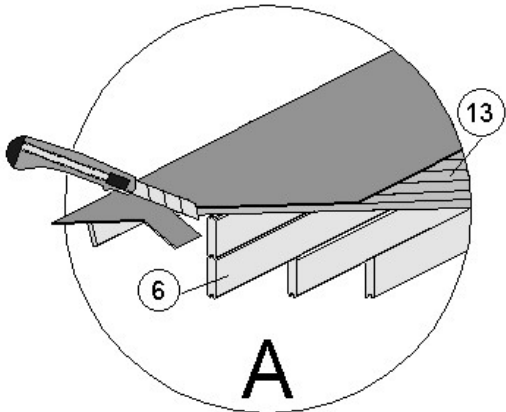

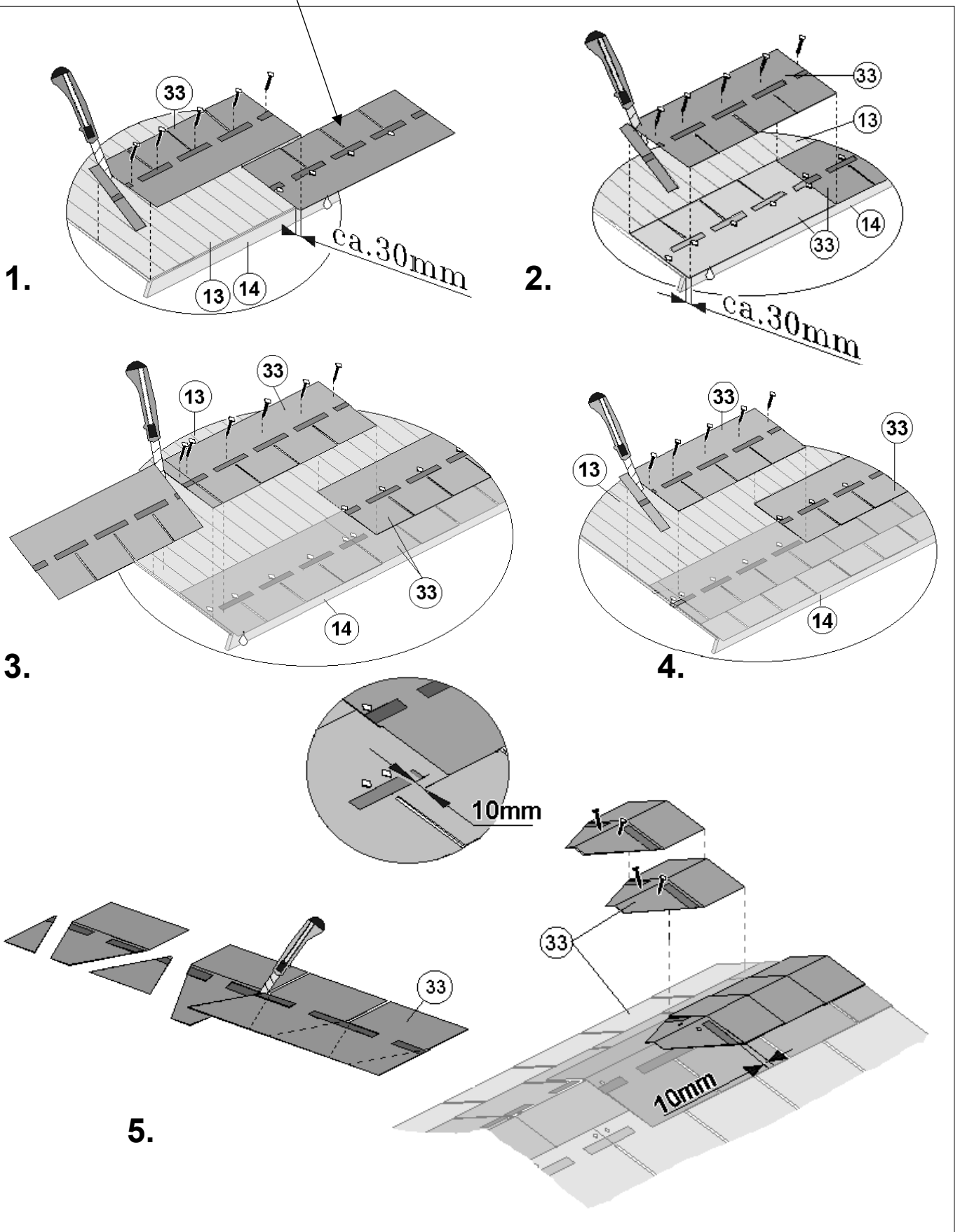
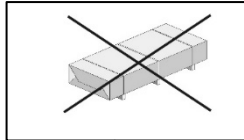
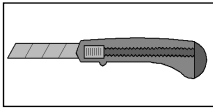
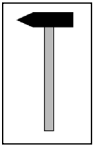

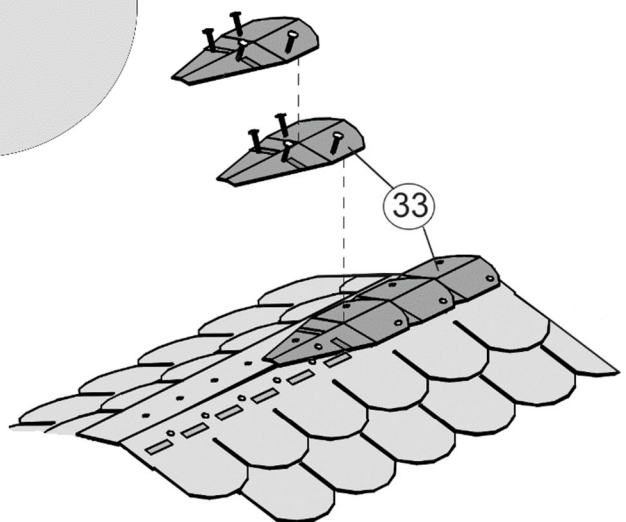
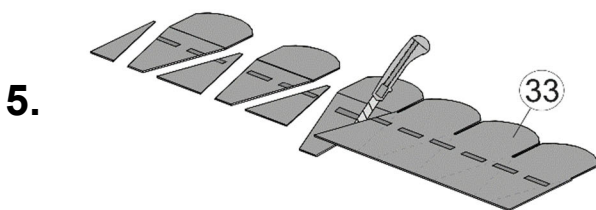
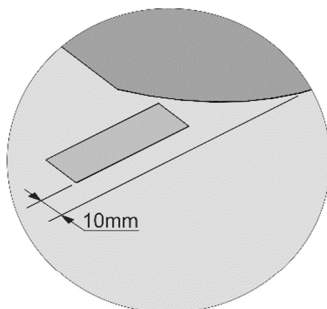
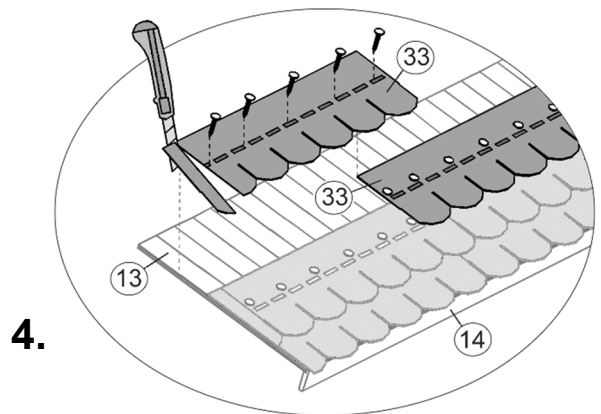
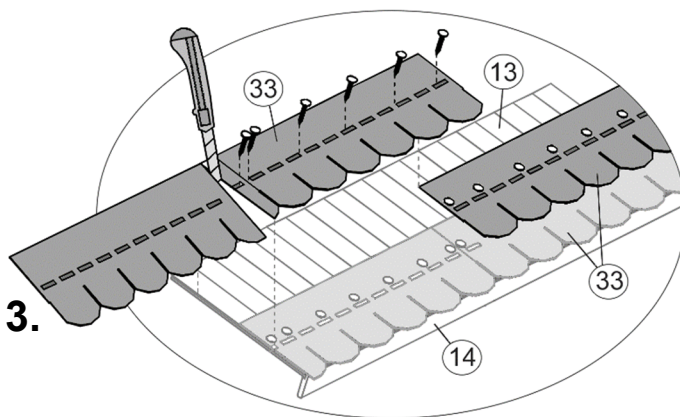
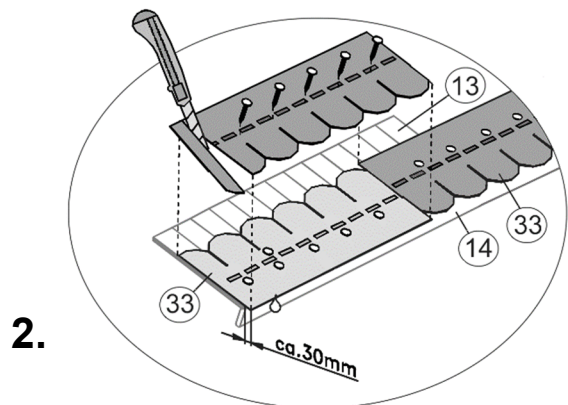
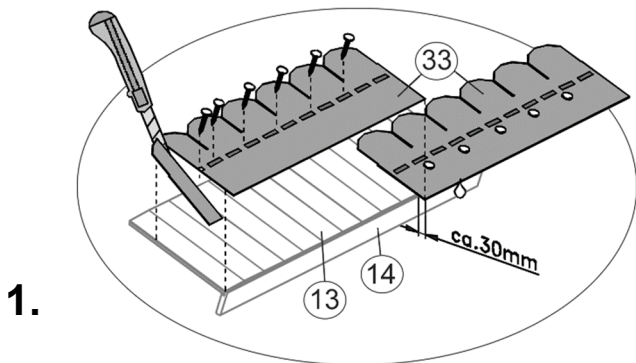

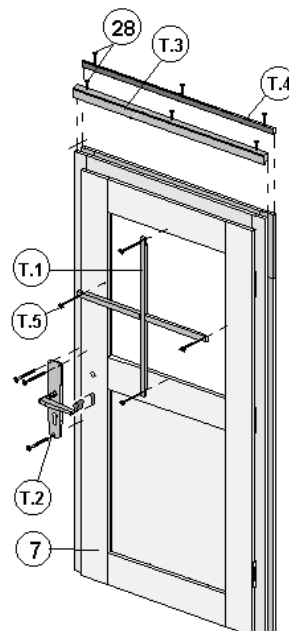

Blockhaustür, 1-flügelig

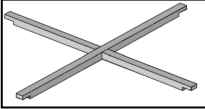
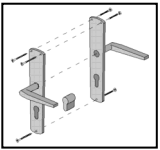
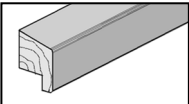
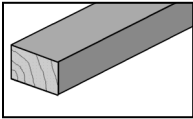

Pos.	Bild	Abmessung
T.1		
T.2		
T.3		35 / 45
T.4		15 / 25
T.5		16 x 30



WS = 21 mm



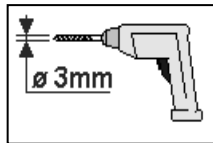

WS = 28 mm

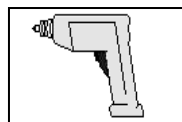
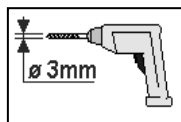
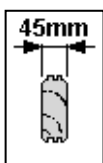
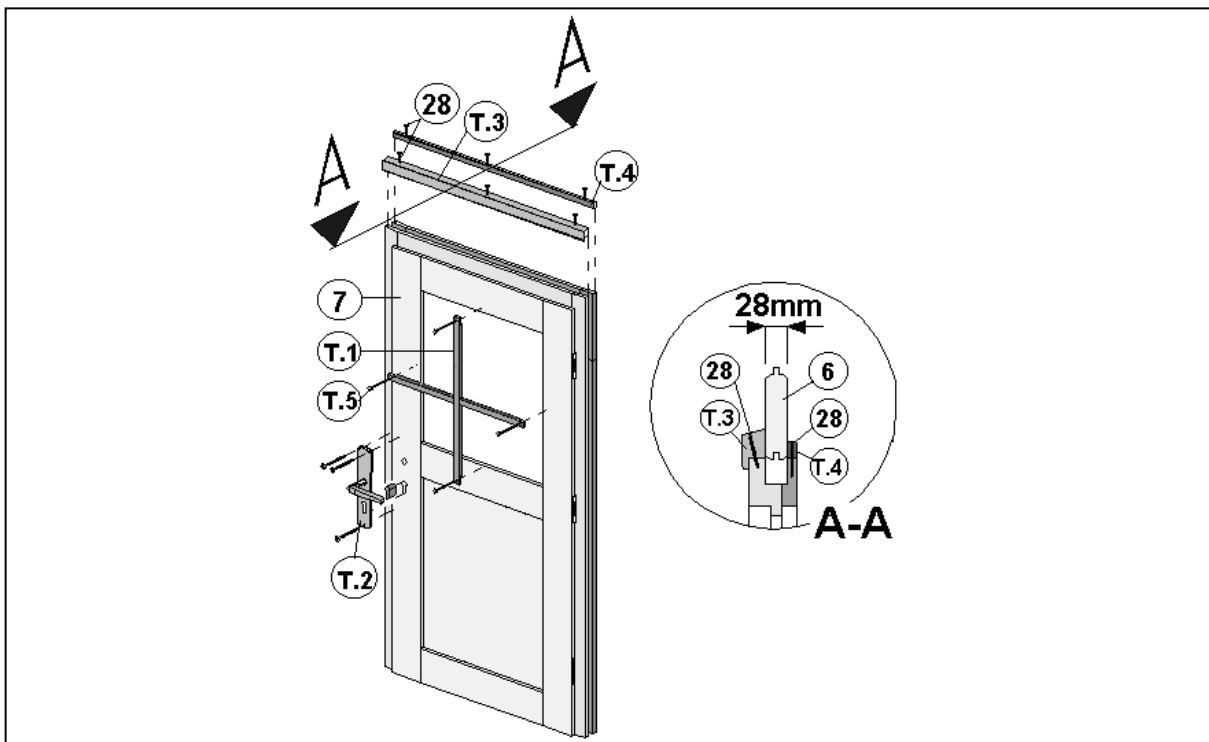

WS = 45 mm

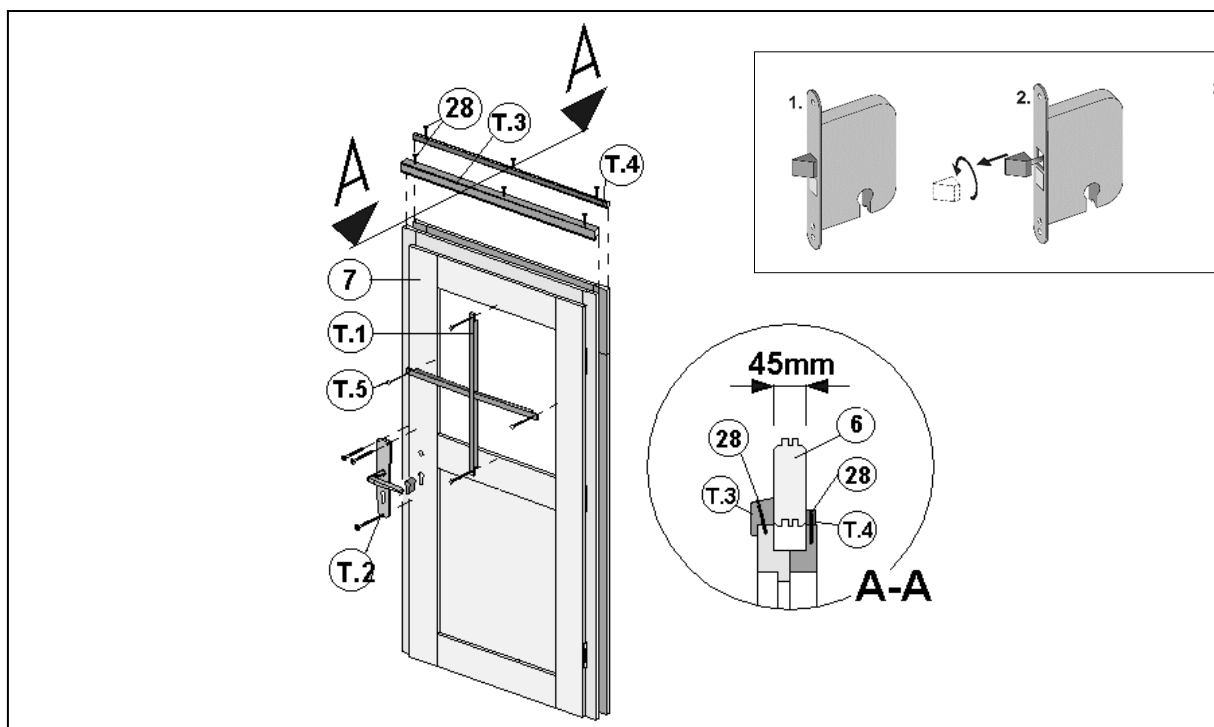

Blockhausfenster, 1-flügelig

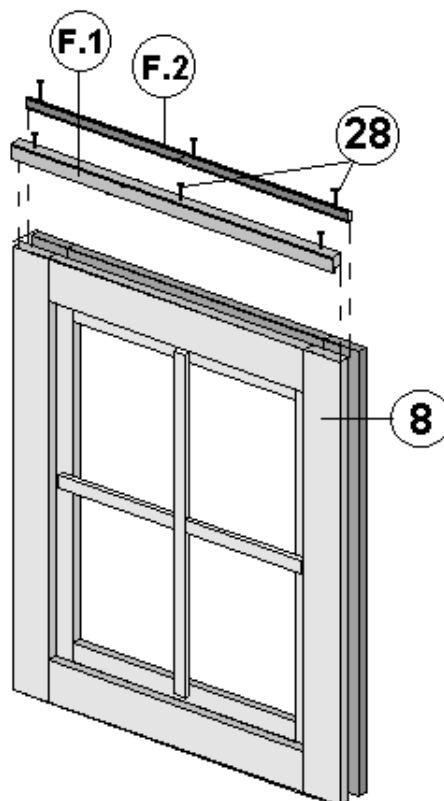

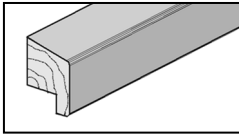
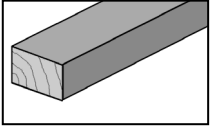
Pos.	Bild	Abmessung
F.1		19 / 45
F.2		15 / 25

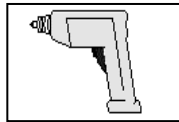

WS = 21 mm





WS = 28 mm



WS = 45 mm

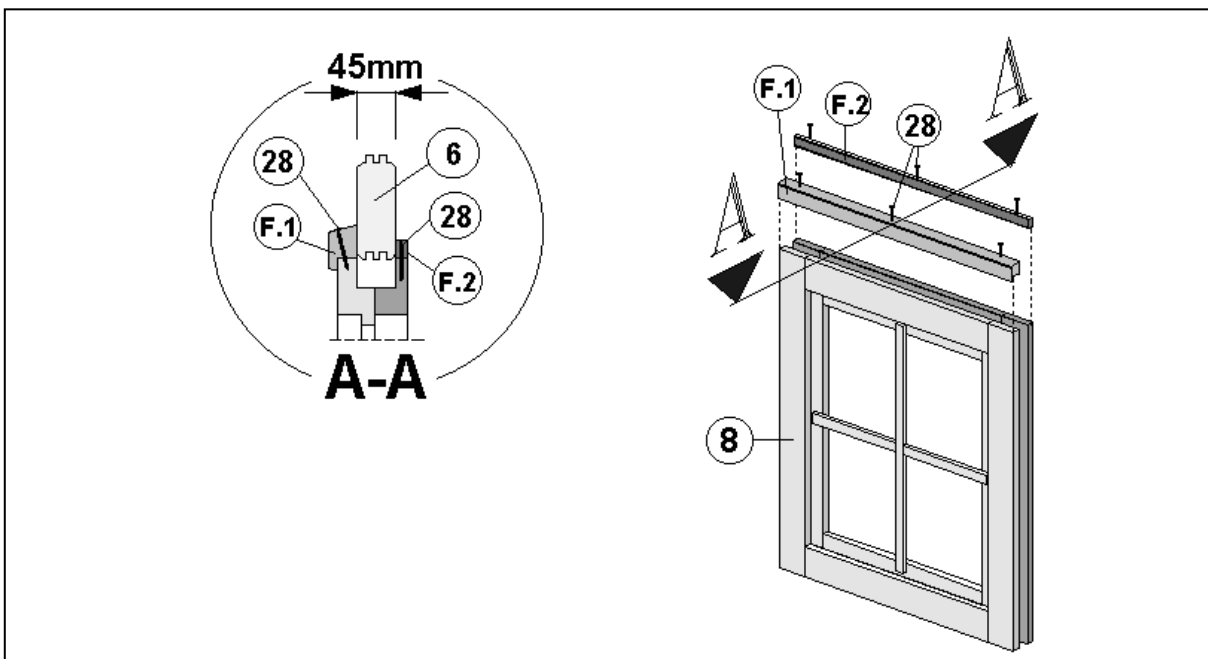

Zusatztür



Pos.	Bild	Abmessung
Zt.1		
Zt.2		
Zt.3		35 / 45
Zt.4		15 / 25
Zt.5		28 / 45
Zt.6		16 x 30

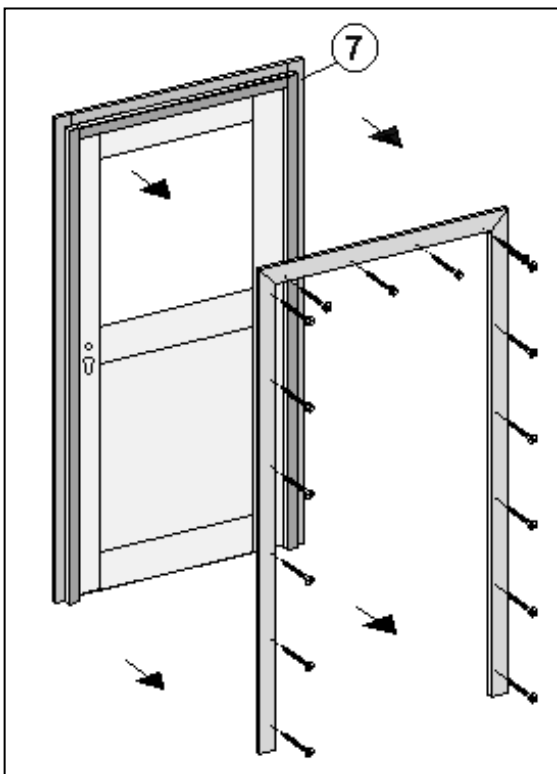
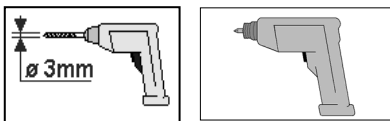
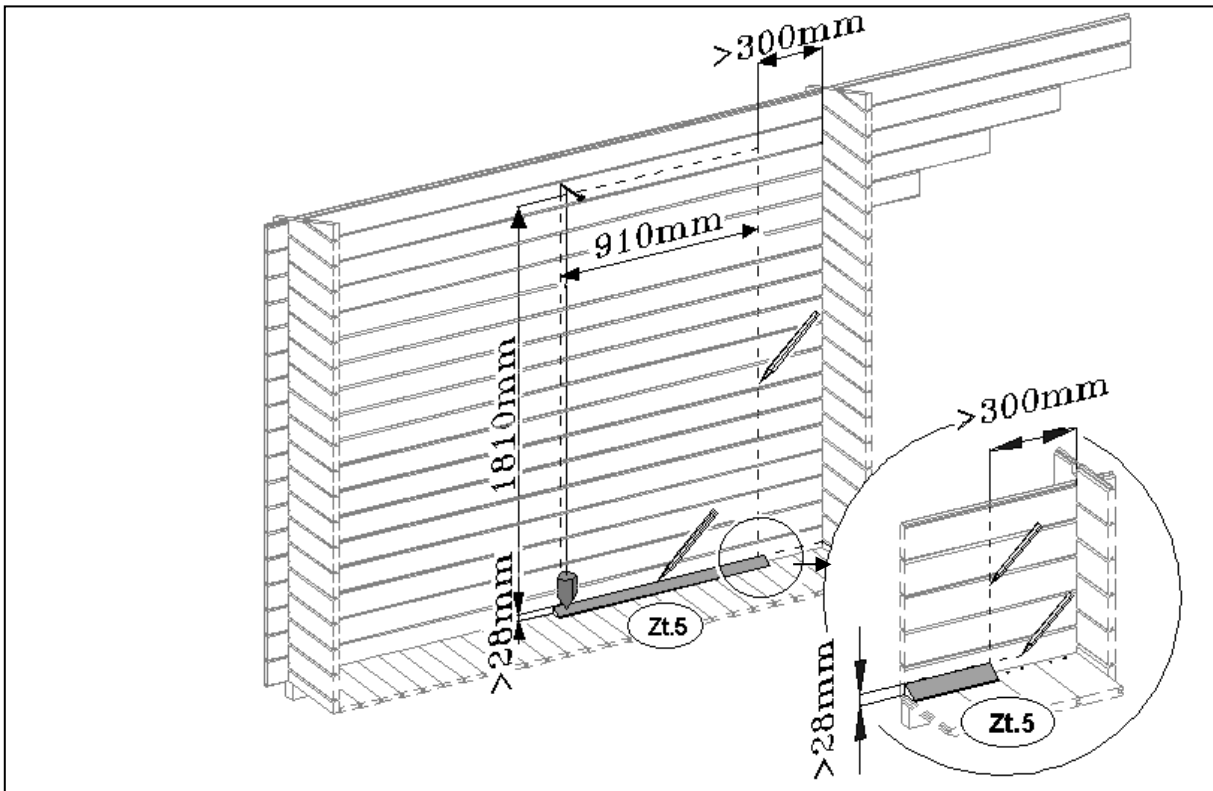
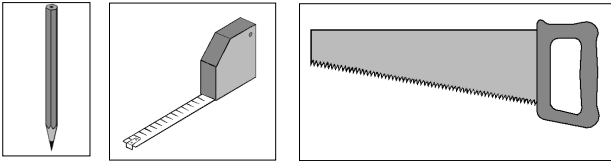



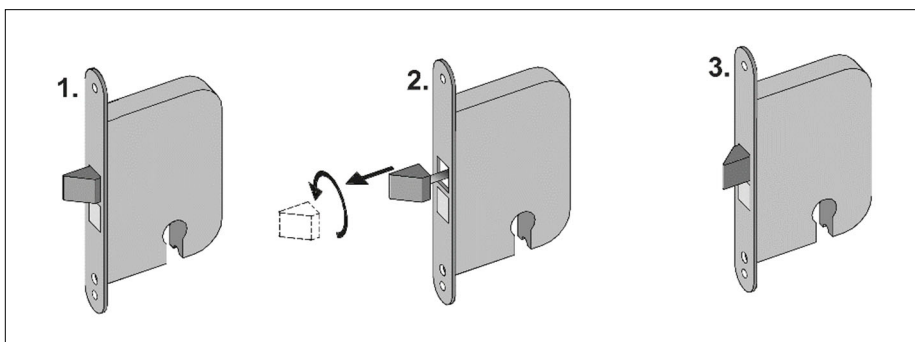
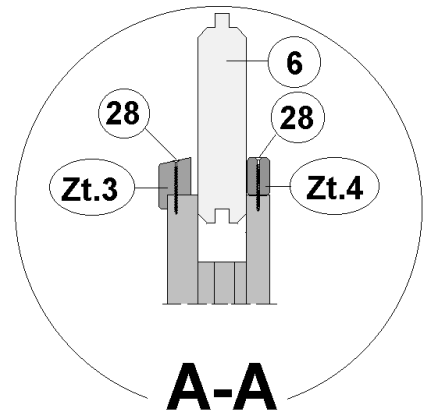
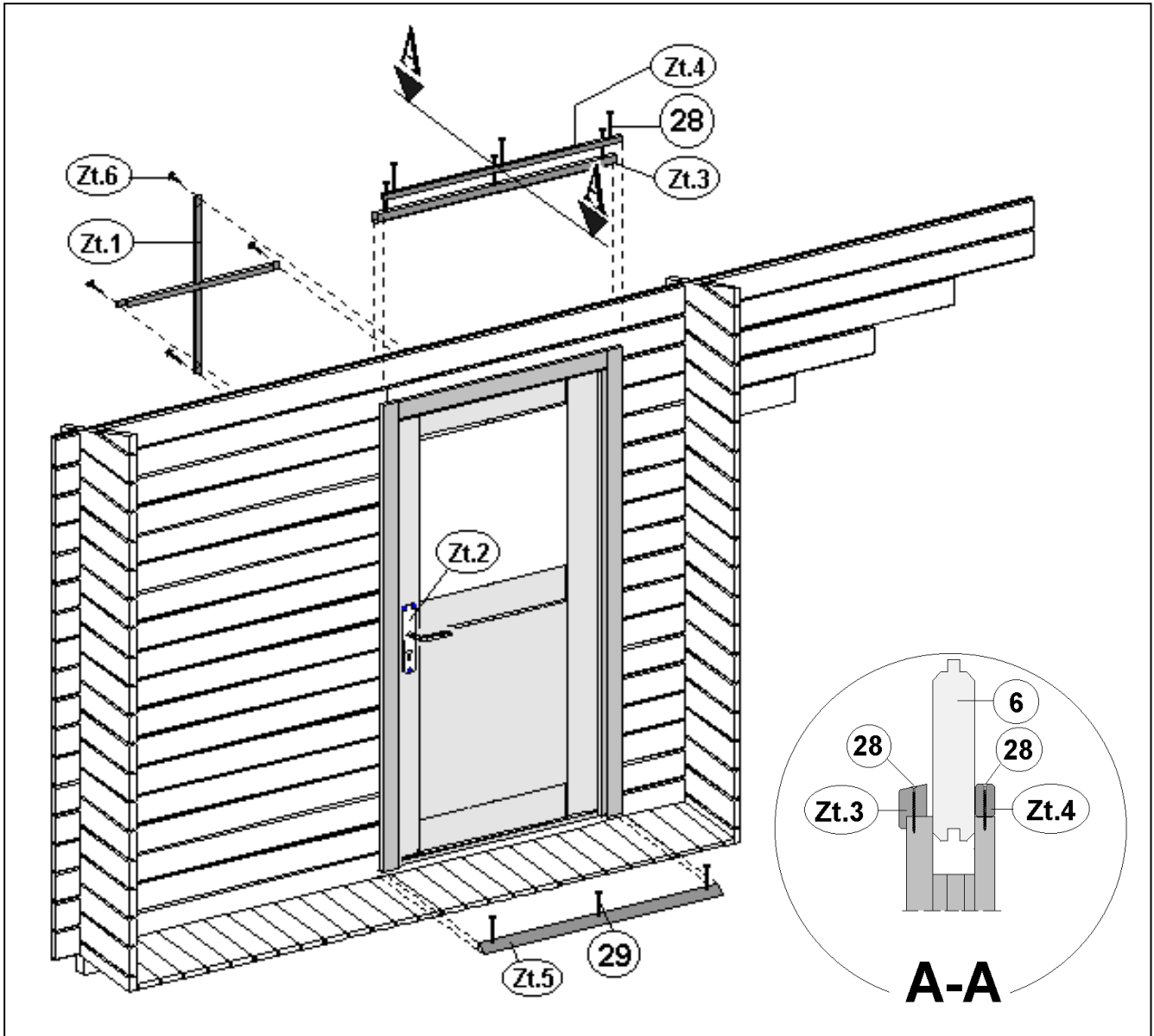
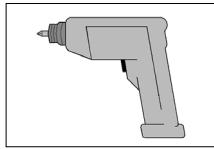

Zusatzfenster

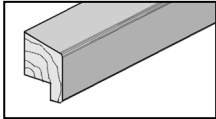
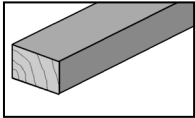

Pos.	Bild	Abmessung
Zf.1		19 / 45
Zf.2		15 / 25

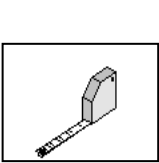

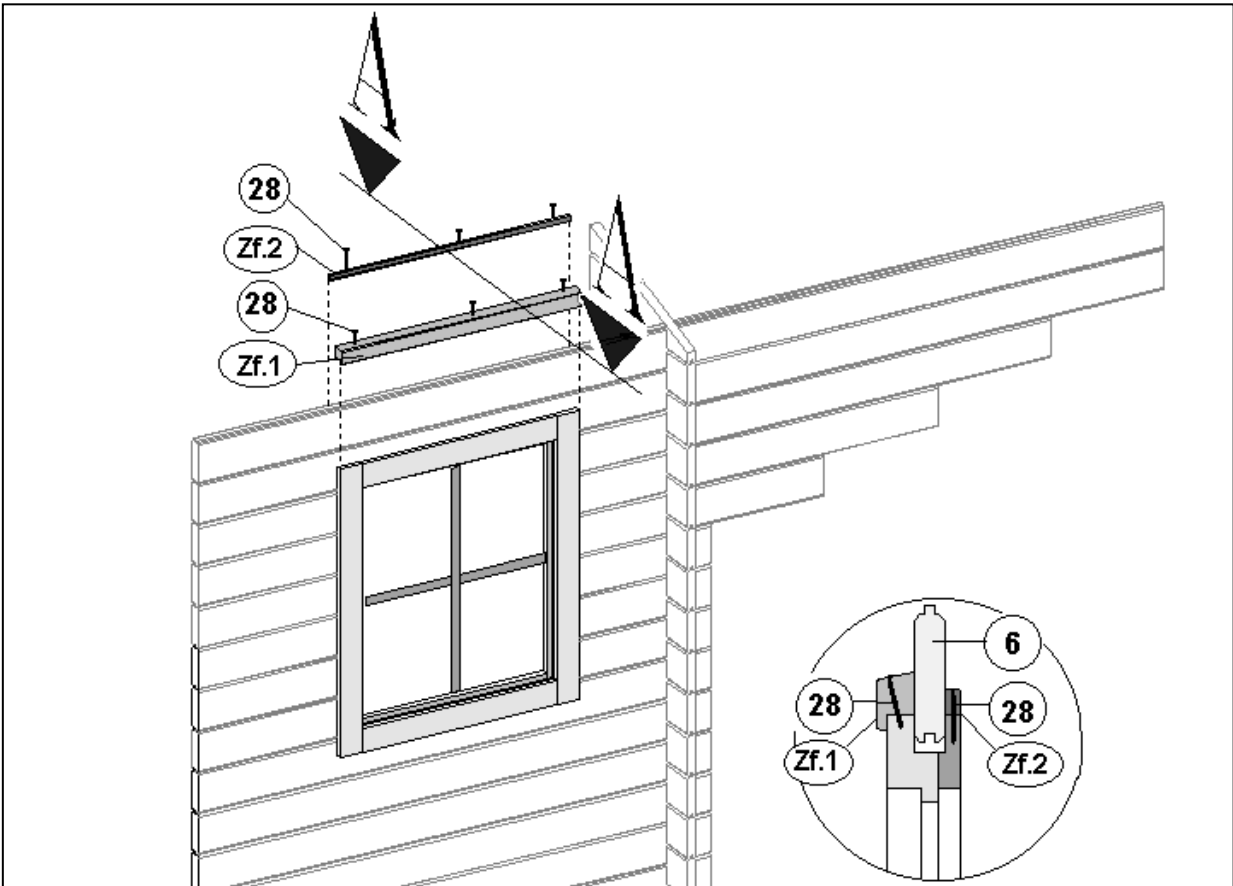

Blockhaus-Tür, 2-flügelig



Pos.	Bild	Abmessung	Bemerkung
D.1		54 / 80 61 / 80 80 / 80	21 mm WS 28mm WS 45mm WS
D.2		54 / 80 61 / 80 80 / 80	21 mm WS 28mm WS 45mm WS
D.3		54 / 80 61 / 80 80 / 80	21 mm WS 28mm WS 45mm WS
D.4		5 / 15	
D.5			
D.6			
D.7		15 / 45	
D.8			
D.9			

Pos.	Bild	Abmessung	Bemerkung
D.10			
D.11		35 / 45	
D.12		15 / 25	
D.13			
D.14		3,0 x 25	
D.15		16 x 30	



21mm WS



28mm WS



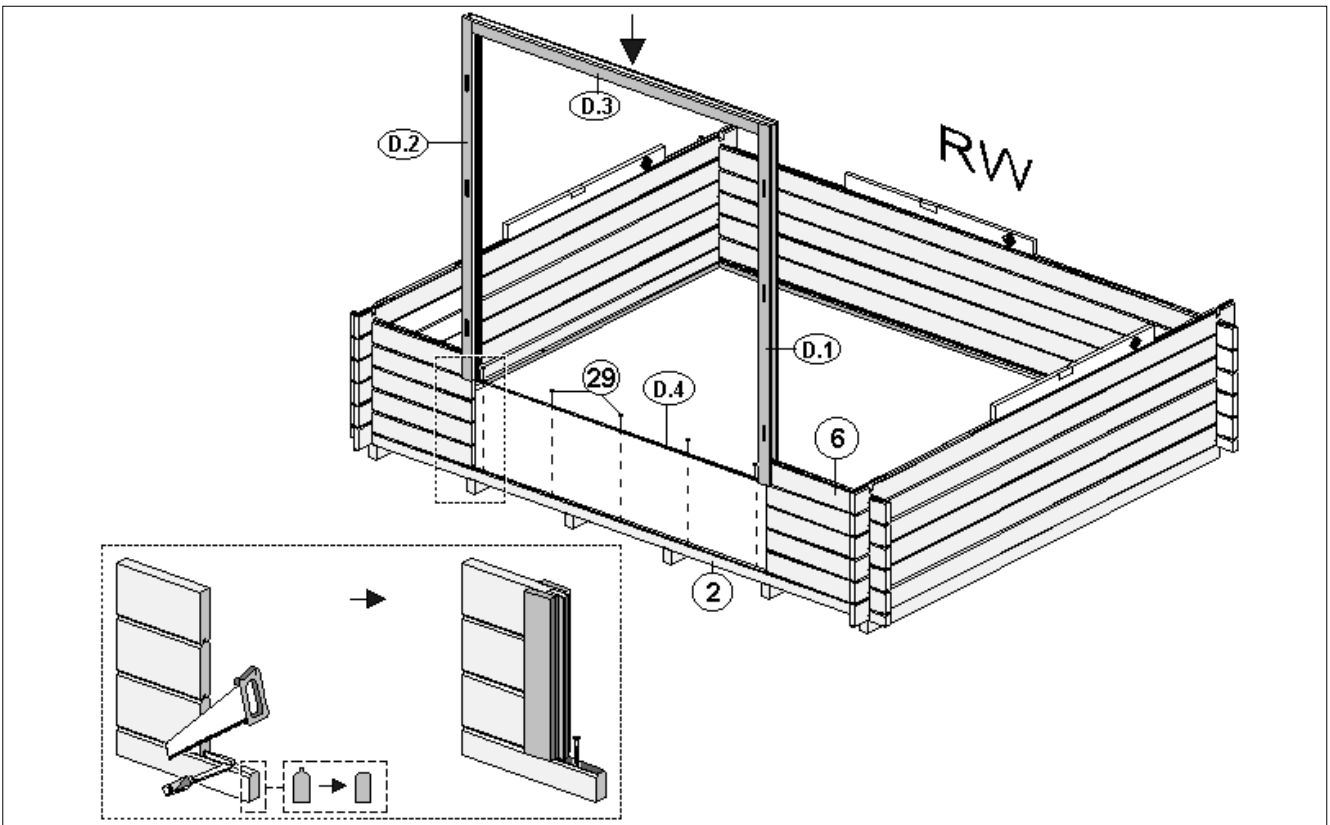
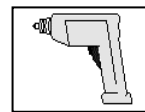
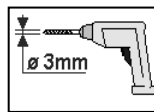
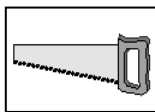
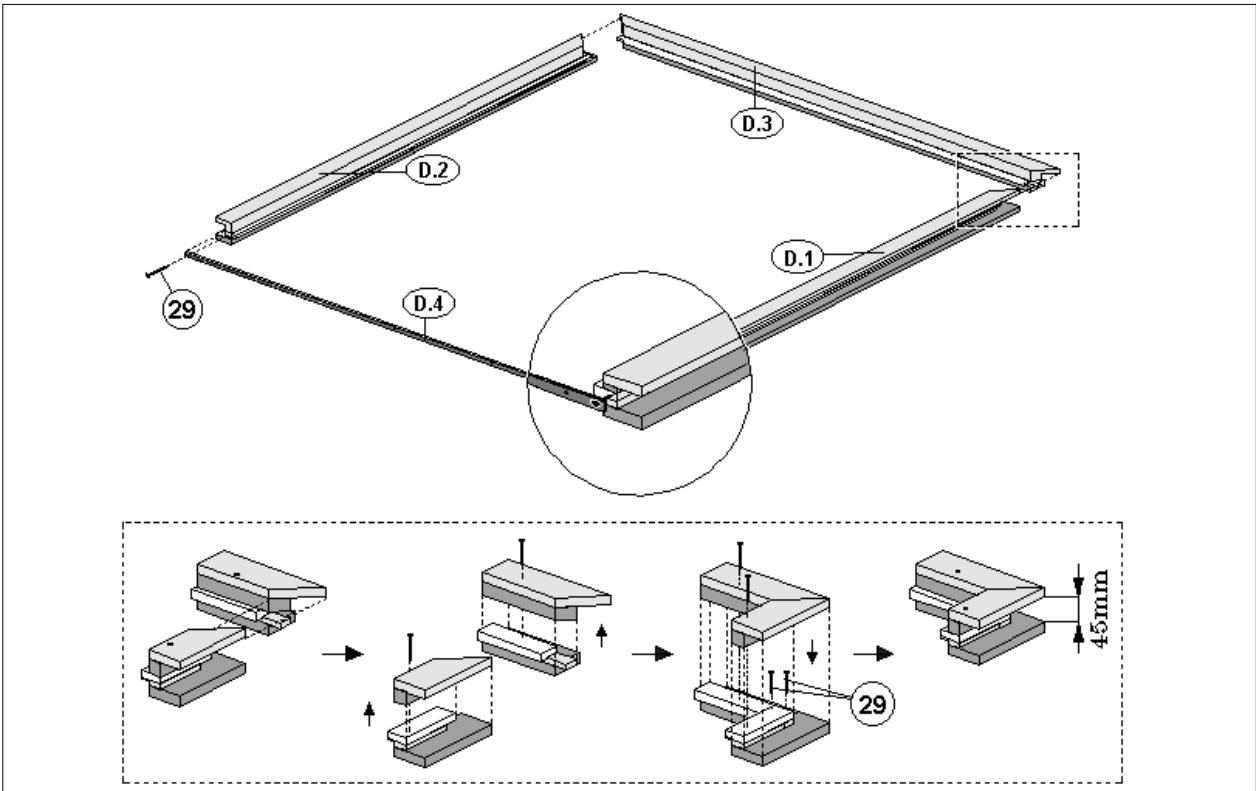
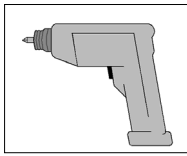
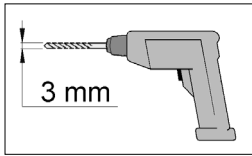
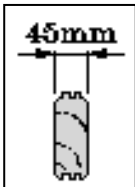



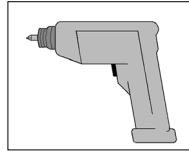

A-A

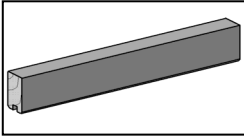
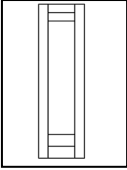
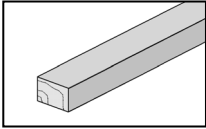
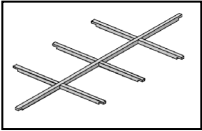
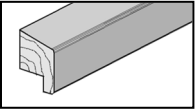
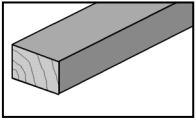
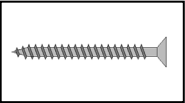
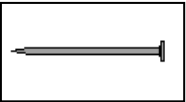

Seitenglaselement

Pos.	Bild	Abmessung
S.1		45 / 40
S.2		
S.3		45 / 70
S.4		
S.5		35 / 45
S.6		15 / 25
S.7		5,0 x 70
S.8		16 x 30

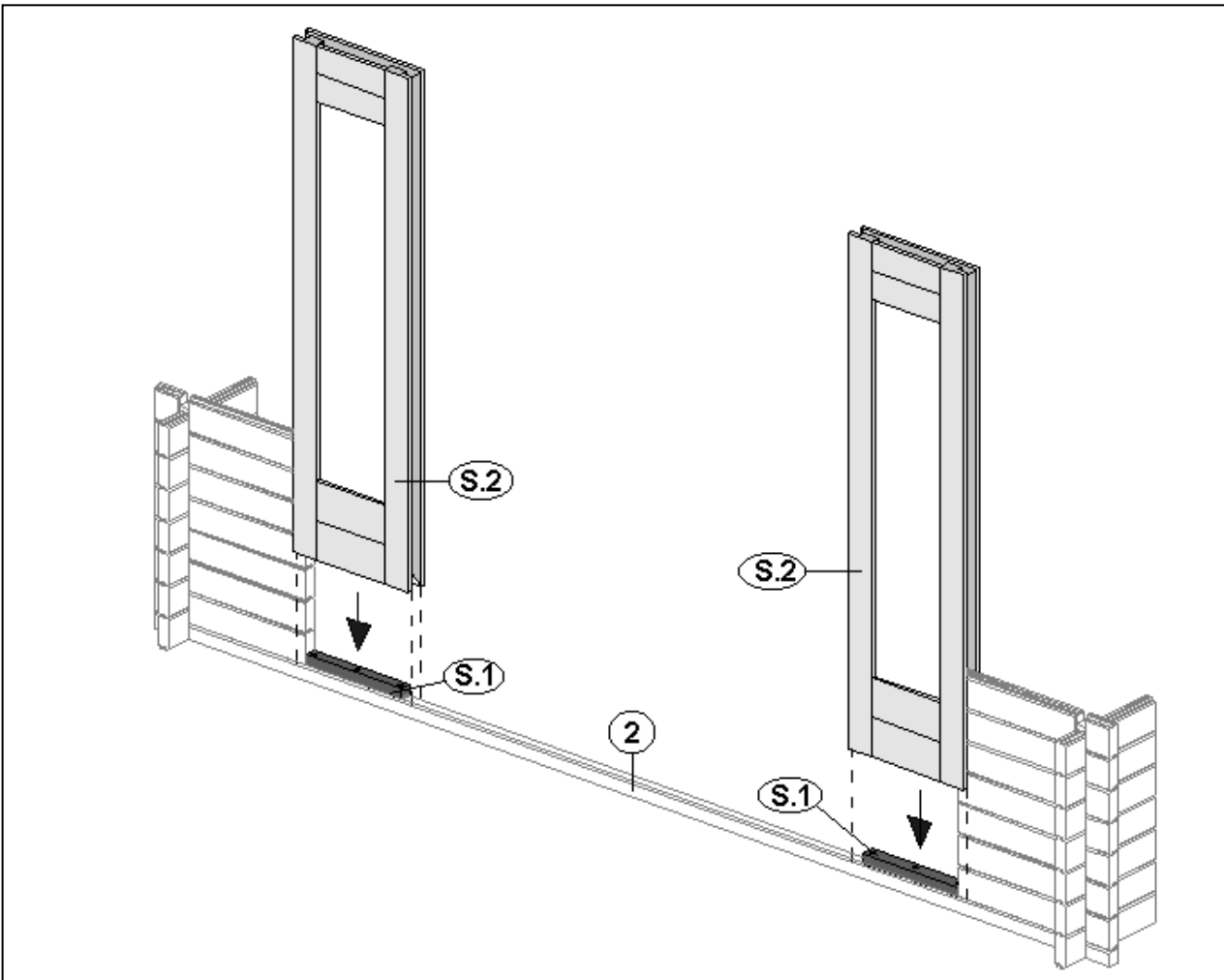
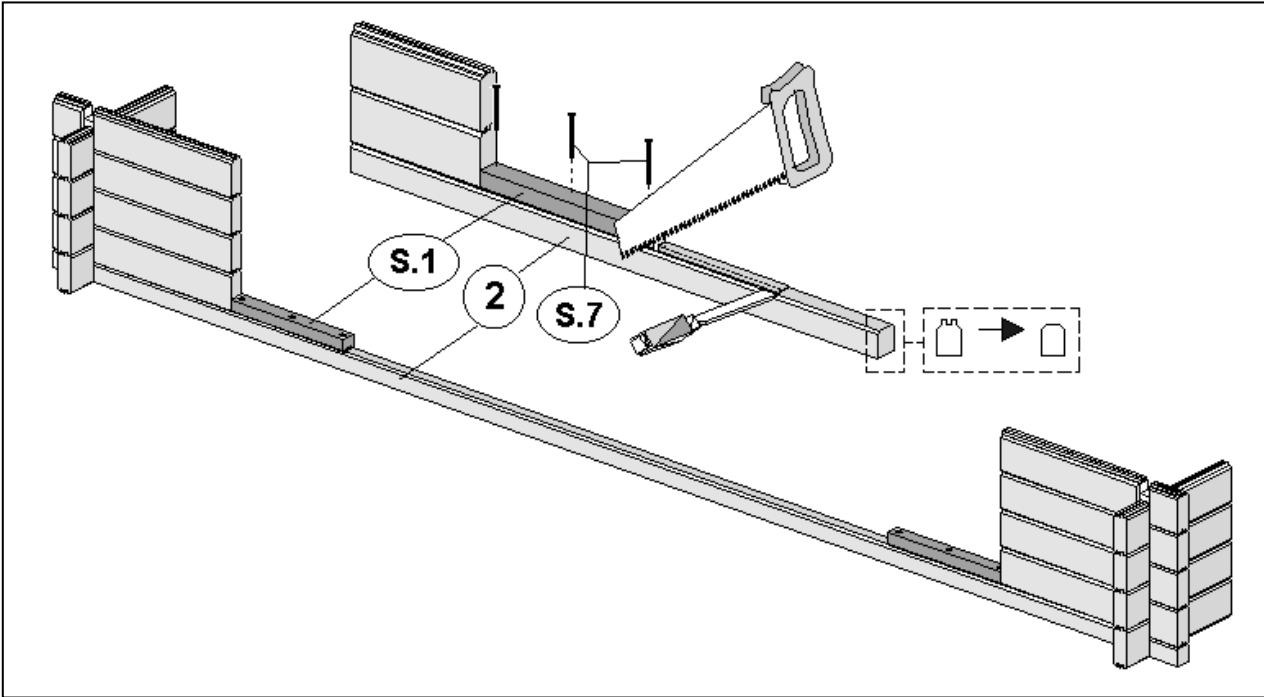
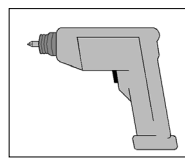
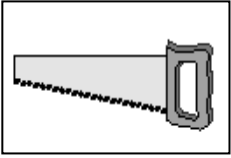

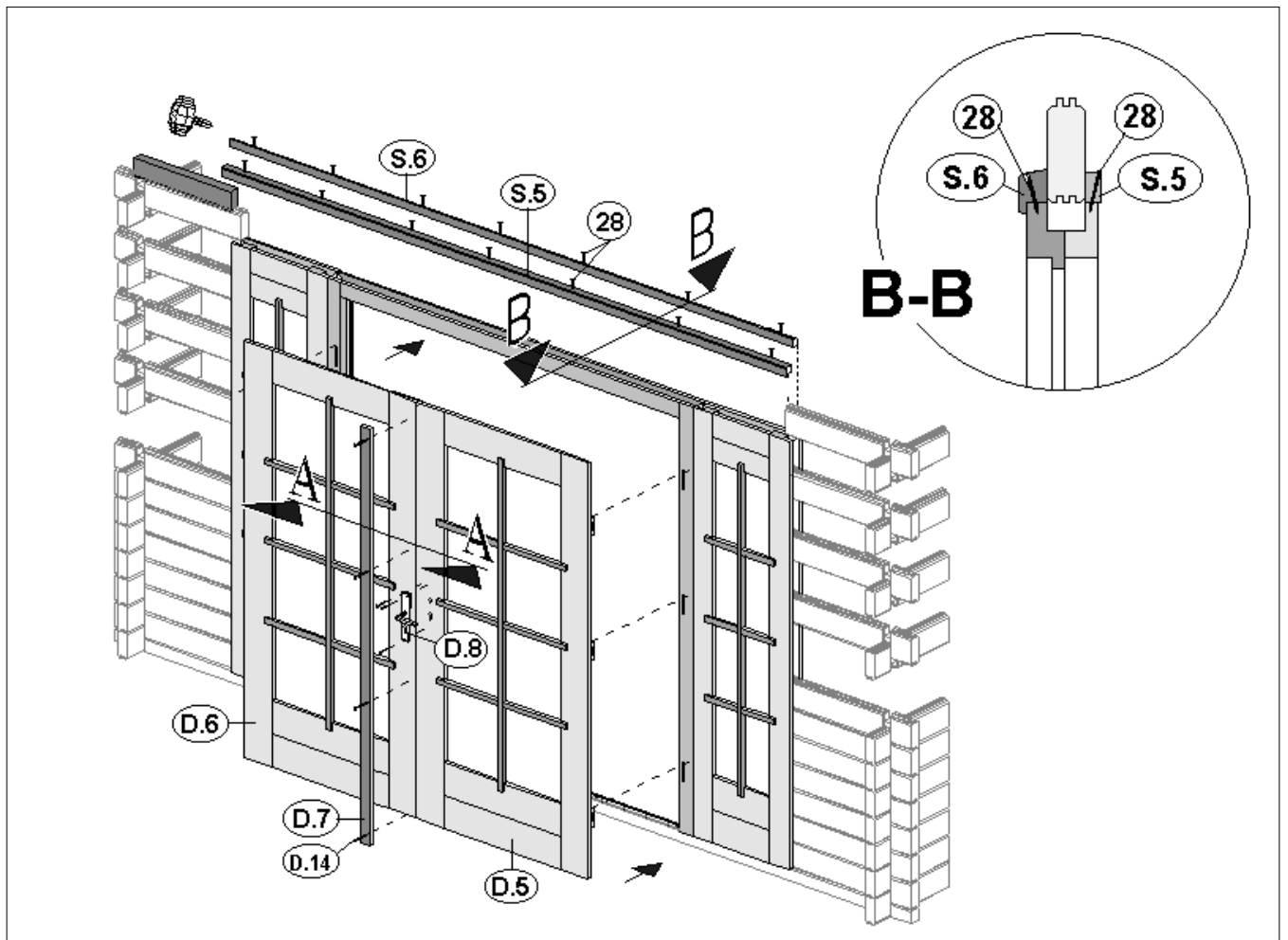
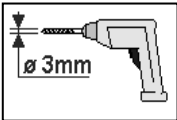
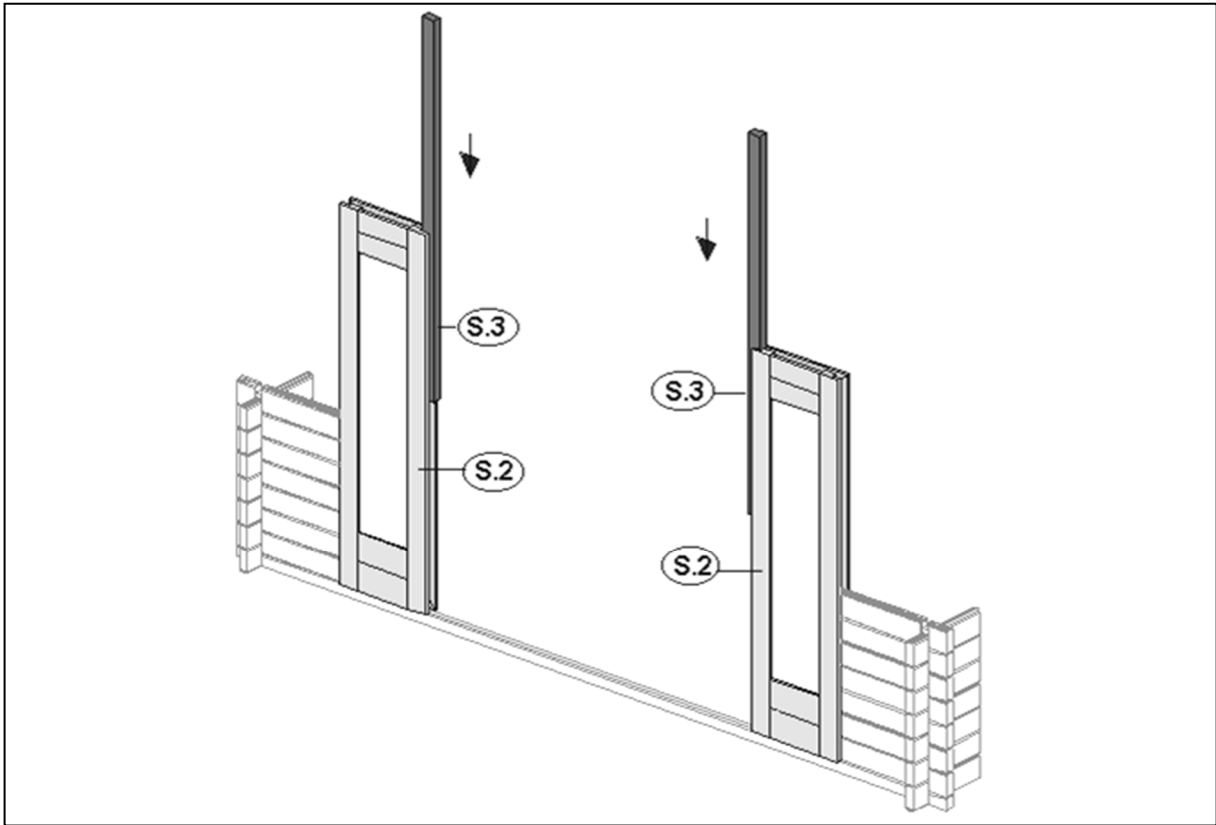



weka Holzbau GmbH, Johannesstr. 16
D-17034 Neubrandenburg
tel. (0049) 395 429080
fax (0049) 395 45129819
EMail: Info@weka-Holzbau.com

MA Art.-Nr.: 800.0286.00.11