

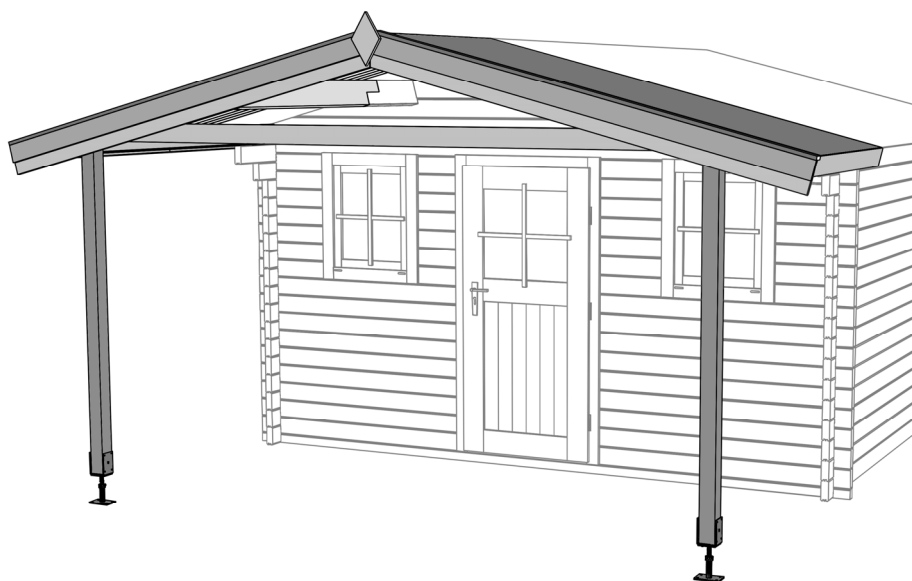

www.weka-holzbau.com

Montageanleitung Vordach

GB	Assembly instructions for porch
F	Notice de montage pour avant-toit
I	Istruzioni per il montaggio della pensilina
E	Instrucciones de montaje del alero
P	Instruções de montagem para sub-telhado
H	Szerelési útmutatás az előtetőhöz
NL	Montagehandleiding voor luifel
HR	Upute za montažu nadstrešnice
SLO	Navodila za montažo nadstreška



Art.-Nr.: 100.1814.34.00
100.1814.38.00



800.0286.00.78

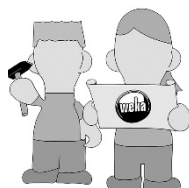

Jetzt
scannen
und noch
mehr entdecken!



Stand: 1906

D

Sehr geehrte Kundin, sehr geehrter Kunde,

danke, dass Sie sich für ein weka-Produkt entschieden haben.

Lesen Sie diese Anleitung vor dem Aufbau bitte vollständig durch, um Montagefehler oder Beschädigungen zu vermeiden.

WICHTIG!

Prüfen Sie bitte sofort anhand der Packliste, ob das Vordach vollständig und unbeschädigt bei Ihnen angekommen ist.

Bitte vernichten Sie die Packliste erst nach Ablauf der Garantiezeit. Diese Liste dient Ihnen zur Kontrolle auf Vollständigkeit der Einzelteile und ist mit dem Kaufbeleg aufzubewahren. Eventuelle Beanstandungen können mit Hilfe dieser Liste problemlos behoben werden. Die Pos.-Nummern der Packliste stimmen nicht mit den Pos.-Nummern folgender Montageanleitung überein.

Wir empfehlen Ihnen die Montage mit 2 Personen durchzuführen.

Zur Verhütung von Unfällen ist zu vermeiden, dass sich Kinder während der Montage in unmittelbarer Nähe aufhalten.

Weiterentwicklungen im Sinne des technischen Fortschritts behalten wir uns vor.

So können geringfügige Abweichungen in den Darstellungen entstehen.

Bitte bohren Sie alle Schraubverbindungen vor, um Beschädigungen an den Holzteilen zu vermeiden!

Folgendes Zeichen macht Sie während der Anleitung nochmals darauf aufmerksam:

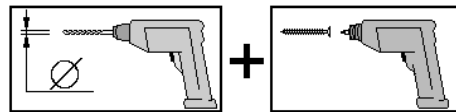

Hinweise zur Montage am Haus

Die Fundamente für die Pfosten sollten einige Tage vor der Vordachmontage entsprechend dem Fundamentplan (Seite 3) gefertigt werden.

Die Montage des Blockbohlenhauses führen Sie gem. der im Hausbausatz liegenden Montageanleitung durch. Bevor die Giebeldreiecke des Hauses aufgesetzt werden beginnen Sie mit der Vordachmontage entsprechend dieser Montageanleitung.

Das Befestigungsmaterial für die Verankerung der Stützenfüße gehört nicht zum Lieferumfang.

Die Stützenfüße sind höhenverstellbar, damit später das Vordach, eventuellen Setzungserscheinungen des Hauses angeglichen werden kann.

Die mitgelieferte Dachpappe dient in erster Linie als vorübergehender Schutz gegen

Witterungseinflüsse. Um einen dauerhaften Schutz zu gewährleisten, empfehlen wir Ihnen die

Dacheindeckung *nur* mit besandeten Bitumenschindeln. Damit schaffen Sie die Grundlage für eine lange Haltbarkeit und Widerstandsfähigkeit gegen Witterungseinflüsse. Andernfalls ist mit Schäden an Ihrem weka-Produkt zu rechnen.

Holzschutz

Das Produkt besteht aus dem natürlichen Rohstoff Holz. Dies macht regelmäßig ausreichende Holzschutzmaßnahmen zwingend erforderlich. Für die fachgerechte Holzschutzbehandlung wenden Sie sich bitte an einen Holzschutzfachmann.

Holzschutzmaßnahmen sind vom Kunden in eigener Verantwortlichkeit durchzuführen. Ohne vorschriftsmäßigen Holzschutz kann keine Gewährleistung übernommen werden. Bitte beachten Sie auch die diesbezüglichen Bestimmungen in unseren Garantieerklärungen.

Wir wünschen Ihnen viel Freude mit Ihrem Holzprodukt.

Garantie

Auf die fachgerechte Weiterverarbeitung und die einwandfreie Funktion gewähren wir eine umfassende Garantie. (gemäß unseren Garantiebestimmungen) Innerhalb der Garantiezeit werden fehlerhafte Teile kostenlos ersetzt. Die durch den Austausch entstehenden Kosten sind im Garantieanspruch nicht enthalten.

Garantieansprüche können nur in Verbindung mit Original-Packlisten und Kaufbeleg in Anspruch genommen werden.

Von der Garantie sind Mängel ausgeschlossen, die bedingt sind durch:
unsachgemäße Fundamente und Gründungen
nicht gemäß dieser Anleitung durchgeführten Montage
eigene Veränderungen am Produkt
fehlerhafte Pflege zur Erhaltung der vorhandenen Holzqualität
Naturkatastrophen oder anderweitige gewaltsame Einwirkungen.

Bei Farbveränderungen, Rissbildung, Verzug oder ähnlichen Veränderungen, die bei Hölzern im Freien normal sind, besteht kein Reklamationsgrund.
Schadhafte oder defekte Einzelteile müssen vor dem Einbau beanstandet werden, da sonst der Garantieanspruch erlischt.

Folgendes Werkzeug sollten Sie vor Beginn der Montage zurechtgelegt haben.

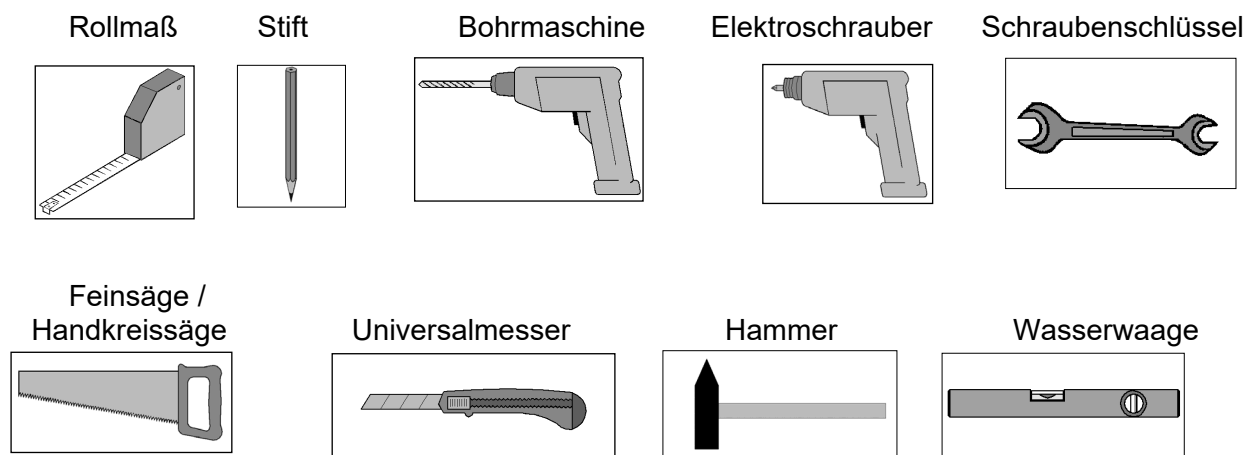

Abkürzungen:	BBH	-	Blockbohlenhaus
	FW	-	Frontwand
	H1	-	Fundamenthöhe, Blockbohlenhaus
	H2	-	Fundamenthöhe, Vordach
	C25/30	-	Beton C25/35
	TB	-	tragfähiger Boden
	ca.	-	cirka
	cm	-	Zentimeter
	OKF	-	Oberkante Fundament



Dear customer

Thank you very much for choosing a weka product.

Read these instructions through completely before assembling your product in order to avoid errors in assembly or damage.

IMPORTANT

Please use the enclosed packing list to check immediately that your roof overhang has been delivered complete and intact.

Please do not dispose of the packing list before the guarantee period has expired. This list enables you to check that all the individual parts are present. It should be retained along with the proof of purchase. The item numbers on the packing list do not correspond to the item numbers in the following assembly instructions.

We recommend that 2 people carry out the assembly.

In order to prevent accidents, we recommend that children be kept out of the direct vicinity during assembly.

We reserve the right to make further technological developments.

This means that there may be minor deviations in the illustrations.

Please drill pilot holes for all screw connections to avoid damaging the wood

The following symbol in the instructions will indicate when this is necessary:

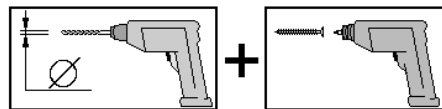

Information for installation on cabin

The foundations for the studs should be laid in accordance with the foundation plan (page 3) a few days prior to assembly of the roof overhang.

Assemble the log cabin in accordance with the assembly instructions included in the cabin kit.

Before erecting the pediments of the cabin, begin by assembling the roof overhang as per these assembly instructions.

The fastening materials for anchoring the support feet are not included in the scope of delivery.

The support feet are height adjustable, so that the porch can be adjusted to any subsequent subsidence.

The roofing felt provided serves primarily as a temporary protection against the weather. TO ensure lasting protection we recommend you to cover the roof *only* with sanded bitumen shingles. This creates the basis for a long life and resistance to the influences of the weather. Otherwise damage to your weka product is to be expected.

Wood protection

The product is made from natural timber, for which regular and adequate wood preservation measures are obligatory. Please contact a wood preservation expert for information on professional preservation measures.

Wood preservation is to be carried out by the customer at his own risk. No guarantee can be given in the event of wood preservation not carried out in accordance with the instructions. Please also note the provisions relating to this in our guarantee. We wish you much pleasure with your wood product.

Warranty

Expert processing and faultless function enables us to offer a comprehensive warranty. (according to our warranty conditions) Within the warranty time, faulty parts will be replaced free of charge. Costs arising as a result of the exchange are not included in the warranty claim. Warranty claims may only be made in conjunction with the original packing list and proof of purchase.

Excluded from the warranty are defects caused by:
improper subsoil and foundations
assembly not carried out in accordance with these instructions
your own alterations to the product
faulty care in the maintenance of the existing wood quality
natural catastrophes or other violent events.

Fluctuations in colour, crack formation, warping or similar changes which are completely normal outdoors are no grounds for making a claim.
Damaged or defective parts must be rejected prior to installation as otherwise the warranty claim will be void.

You should have the following tools to hand before beginning assembly:

tape measure

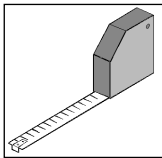

pencil

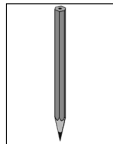

drill

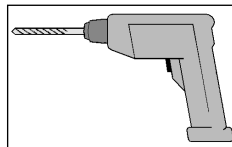

electric screwdriver

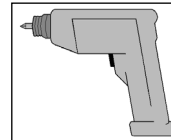

spanner

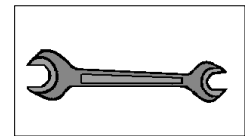

slitting saw /
manual circular saw

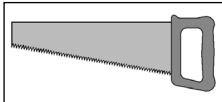

universal cutter

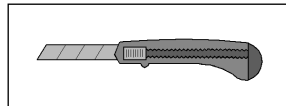

hammer



Spirit level

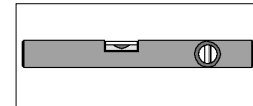

Abbreviations:

BBH	-	Blockboard cabin
FW	-	Front wall
H1	-	Foundation height, log cabin
H2	-	Foundation height, roof overhang
C25/30	-	Concrete C25/30
TB	-	Load-bearing wall
approx.	-	approximately
cm	-	centimetres
OKF	-	Upper edge of foundation

F

Chère cliente, cher client,

Nous vous remercions d'avoir choisi un produit weka.

Lisez entièrement la présente notice avant de procéder à l'assemblage afin d'éviter toute erreur de montage ou d'éventuels dommages.

IMPORTANT !

Veuillez vérifier immédiatement, à l'aide de la liste de colisage, si l'avant-toit est arrivé complet et en bon état.

Ne détruisez la liste de colisage qu'une fois la garantie écoulee. Cette liste vous permet de vérifier si les pièces détachées sont complètes et doit être conservée avec le justificatif d'achat. Elle vous permettra de faire valoir aisément d'éventuelles réclamations. Les numéros-repères de la liste de colisage ne sont pas identiques aux numéros-repères de la présente notice de montage.

Nous vous recommandons d'effectuer le montage à 2 personnes.

Pour prévenir les accidents, faites en sorte que les enfants ne se tiennent pas à proximité durant le montage.

Nous nous réservons le droit d'apporter aux produits des modifications liées au progrès technique, ce qui peut se traduire par de légères différences par rapport aux illustrations.

Pré-percez tous les assemblages vissés afin d'éviter d'endommager les éléments en bois !

Ceci vous est rappelé par le symbole suivant dans la notice :

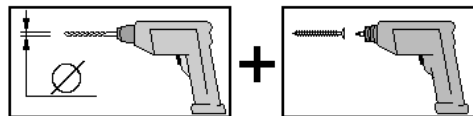

Remarques sur le montage sur l'abri

Les fondations pour les poteaux doivent être préparées quelques jours avant le montage de l'avant-toit conformément au plan de fondation (page 3).

Effectuez le montage de l'abri en madriers conformément à la notice de montage fournie dans le kit de l'abri. Avant de placer le triangle de pignon de l'abri, commencez par le montage de l'avant-toit conformément à cette notice de montage.

Le matériel de fixation pour l'ancrage des pieds d'appui n'est pas compris dans la livraison.

Les pieds d'appui sont réglables en hauteur, pour que l'avant-toit et les phénomènes de tassement éventuels de l'abri puissent être compensés.

Le carton bitumé fourni sert en premier lieu de protection temporaire contre les intempéries. Afin de garantir une protection durable, nous vous recommandons de procéder à la couverture *uniquement* avec des bardeaux bitumés sablés. Vous ferez ainsi le nécessaire pour conférer à votre produit une grande longévité et résistance aux intempéries. A défaut, vous risquez fortement d'endommager votre produit weka.

Protection du bois

Cet article est en bois brut naturel. Il est impératif d'entretenir et de protéger le bois régulièrement.

Veuillez vous renseigner auprès d'un spécialiste du bois pour connaître les traitements appropriés.

Les mesures de protection du bois sont à effectuer par le client, sous sa propre responsabilité.

Aucune garantie ne peut être accordée si le bois n'a pas été protégé selon les règles. Veuillez également vous reporter aux dispositions correspondantes de nos déclarations de garantie.

Nous vous souhaitons beaucoup de plaisir à l'usage de votre article en bois.

Garantie

Nous vous garantissons une transformation spécialisée ainsi qu'un fonctionnement impeccable de tous les produits (dans le cadre de nos conditions de garantie) Les pièces défectueuses seront remplacées gratuitement durant la période de garantie. Les coûts de remplacement ne sont en revanche pas compris dans la garantie.

L'original de la liste de colisage et l'original du justificatif d'achat sont nécessaires pour faire valoir tous droits relatifs à la garantie.

Sont exclus de la garantie, les défauts provenant des situations suivantes :

fondations et sols non conformes

montage non conforme aux présentes instructions

modifications apportées au produit

entretien irrégulier du bois entraînant une perte de qualité

catastrophes naturelles ou autres cas de force majeure.

Les changements de couleur, la formation de fissures, la déformation ou les autres modifications, qui sont des phénomènes normaux sur les bois exposés en plein air, ne sont pas un motif de réclamation.

Des pièces défectueuses ou endommagées doivent faire l'objet d'une réclamation avant le montage, après celui-ci elles ne seront plus garanties.

Pour le montage, nous vous recommandons de préparer les outils suivants.

Mètre de poche

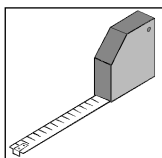

Crayon

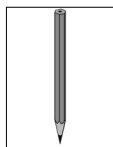

Perceuse

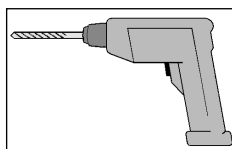

Tournevis électrique

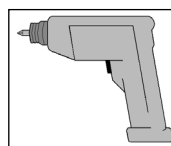

Clé de vissage

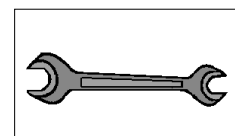

Scie de menuisier /
scie circulaire portative

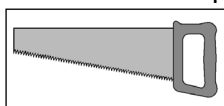

Cutter

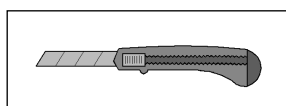

Marteau

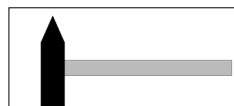

Niveau à bulle

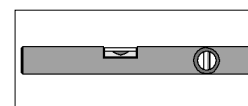

Abréviations :

BBH	-	Abri en madriers
FW	-	paroi avant
H1	-	Hauteur de fondation, abri en madriers
H2	-	Hauteur de fondation, avant-toit
C25/30	-	Béton C25/30
TB	-	sol stable
env.	-	environ
cm	-	centimètre
OKF	-	Bordure supérieure de fondation



Egredi clienti,

ci congratuliamo con voi per avere scelto un prodotto weka.

Prima del montaggio leggete con cura le presenti istruzioni al fine di evitare errori di montaggio o danni.

IMPORTANTE!

Controllate subito con l'ausilio della lista di imballaggio che la pensilina sia stata fornita completa e senza danni.

Vi preghiamo di conservare la lista di imballaggio fino alla scadenza del periodo di garanzia.

Questa lista serve per controllare la completezza della fornitura e deve essere conservata insieme allo scontrino. Con l'ausilio della lista è possibile risolvere eventuali reclami. I numeri di posizione della lista di imballaggio non corrispondono ai numeri di posizione delle seguenti istruzioni di montaggio.

Raccomandiamo di eseguire il montaggio in 2 persone.

Per la prevenzione di infortuni è necessario evitare la presenza di bambini nelle immediate vicinanze dei lavori di montaggio.

Ci riserviamo di apportare ulteriori modifiche ai fini del progresso tecnologico.

Per tale motivo è possibile che nelle rappresentazioni vengano a crearsi lievi differenze.

Per evitare danni agli elementi in legno si raccomanda di preforare tutti i punti di avvitaggio a vite!

Il presente simbolo richiama la vostra attenzione su tale particolare nel corso delle istruzioni:

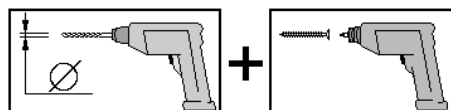

Informazioni per il montaggio a casa

Le fondamenta per i montanti devono essere realizzate alcuni giorni prima del montaggio della pensilina come da disegno delle fondamenta (pagina2).

Eseguite il montaggio della casetta in listoni di legno in base alle istruzioni contenute nel kit del prefabbricato. Prima di montare il triangolo del frontone della casa montate la pensilina come illustrato nelle istruzioni.

Il materiale di fissaggio per l'ancoraggio delle colonne di base non è compreso nella fornitura.

Le colonne di base sono regolabili in altezza in modo da adattare la pensilina ad eventuali forme di composizione della casa.

Il cartone catramato fornito serve in primo luogo come protezione provvisoria contro le intemperie.

Per garantire una protezione duratura, consigliamo la copertura del tetto con *solo* tegole canadesi bituminose sabbiate. In questo modo create le basi per una lunga durata e resistenza alle intemperie. In caso contrario, potranno verificarsi dei danni al vostro prodotto weka.

Protezione legno

Il prodotto è composto dalla materia prima naturale del legno che rende le misure di protezione del legno assolutamente necessarie. Per il trattamento di protezione del legno a regola d'arte rivolgersi ad un esperto di protezione del legno.

Le misure di protezione del legno devono essere eseguite dal cliente sotto la sua responsabilità.

Senza protezione del legno prescritta non può essere assunta nessuna garanzia. Osservare anche le disposizioni al riguardo nelle nostre dichiarazioni di garanzia. Vi auguriamo un buon utilizzo del nostro prodotto legno.

Garanzia

La lavorazione a regola d'arte e la perfetta funzionalità è ulteriormente assicurata dalla garanzia che offriamo su tutti i pezzi. (conformemente alle nostre condizioni di garanzia) Durante il periodo di garanzia i componenti difettosi vengono sostituiti gratuitamente. La garanzia non comprende i costi causati dalla sostituzione di componenti difettosi.

La garanzia può essere applicata solamente se accompagnata dalla lista di imballaggio e dallo scontrino di acquisto originali.

La garanzia non copre difetti causati da: fondamenta e fondi non appropriati, un montaggio non eseguito come specificato nelle presenti istruzioni, modifiche al prodotto apportate di propria iniziativa, manutenzione errata per la conservazione della presente qualità del legno, catastrofi naturali o altri fattori di intervento violento.

Per modifiche cromatiche, formazione di crepe, distorsioni o cambiamenti simili, normali per legni all'aperto, non vi è motivo di reclamo.

Prima di procedere con il montaggio, le parti danneggiate o difettose devono essere eliminate, in caso contrario la garanzia decade.

Prima di iniziare con il montaggio tenere a portata di mano i seguenti utensili.

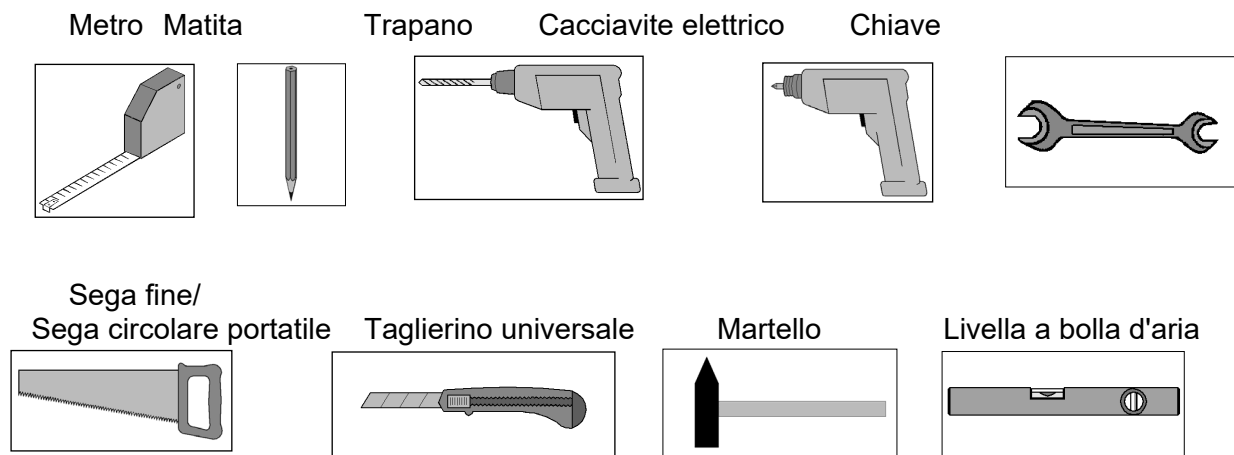

Abbreviazioni:

BBH	-	Casetta in listoni di legno
FW	-	Parete anteriore
H1	-	Dimensioni delle fondamenta, casetta in listoni di legno
H2	-	Dimensioni delle fondamenta, pensilina
C25/30	-	Calcestruzzo C25/30
TB	-	Pavimento portante
ca.	-	circa
cm	-	Centimetri
OKF	-	Bordo superiore fondamenta

E

Estimado/a cliente:

Gracias por elegir un producto Weka.

Lea de principio a fin estas instrucciones de montaje para evitar errores o desperfectos.

¡IMPORTANTE!

Compruebe con la lista de embalaje si el alero ha llegado a sus manos completo e intacto. No elimine la lista de embalaje antes de que venza el periodo de garantía. Esta lista sirve para controlar la integridad de las piezas y debe guardarse junto con el comprobante de compra. Esta lista permitirá atender con éxito cualquier reclamación que pudiera surgir. Los números de artículo que figuran en la lista de embalaje no coinciden con los números especificados en las siguientes instrucciones de montaje.

Le aconsejamos realizar el montaje con 2 personas.

Para prevenir accidentes debe evitarse la presencia de niños en las proximidades del lugar de montaje.

Quedan reservados los derechos de desarrollo en relación con las mejoras técnicas.

Pueden producirse ligeras discrepancias en los dibujos y diagramas.

¡Por favor, haga previamente las perforaciones para todas las uniones atornilladas a fin de evitar daños en los elementos de madera!

El siguiente pictograma le recordará esta indicación durante el montaje:

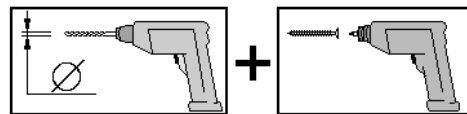

Indicaciones para el montaje en la casa

Los cimientos para los postes deberían hacerse algunos días antes del montaje del alero, conforme al plano de cimientos (página 3).

El montaje de la casa de tablonos debe realizarse de acuerdo con las instrucciones que se incluyen en el juego de montaje. Antes de colocar los triángulos de frontispicio de la casa, comience con los trabajos de montaje del alero siguiendo estas instrucciones de montaje.

El material de fijación para el anclaje de los pies de apoyo no está incluido en el volumen de suministro.

Los pies de apoyo son regulables en altura, para que más adelante sea posible adaptar el alero a eventuales fenómenos de asiento de la causa.

Para garantizar una protección duradera, le recomendamos el tejado *sólo* con ripias bituminosas arenadas. De este modo, consigue la base para una larga durabilidad y resistencia contra los efectos de la intemperie. De lo contrario, es probable que se produzcan daños en su producto weka.

Preservación de la madera

El producto se compone de la materia prima natural madera. Esto hace que sea imprescindible tomar regularmente suficientes medidas de conservación de la madera. Para realizar un correcto tratamiento de conservación de la madera, póngase en contacto con un experto en conservación de maderas.

Las medidas de conservación de la madera las debe realizar el cliente bajo su responsabilidad.

Sin una conservación de la madera según prescripción, no se puede asumir ninguna garantía.

También tenga en cuenta las disposiciones que figuran en nuestra declaración de garantía a este respecto.

Le deseamos que disfrute de su producto de madera.

Garantía

Otorgamos una completa garantía sobre el procesamiento competente y el funcionamiento impecable (conforme a nuestras disposiciones de garantía). Durante el tiempo de garantía todas las piezas defectuosas se reemplazarán gratuitamente. Los costes producidos por el cambio no se incluyen en el derecho a garantía.

Las pretensiones que se desprendan de la garantía se aceptarán sólo en relación con la lista de embalaje original y el comprobante original de compra.

Se excluyen de la garantía los defectos debidos a:

- cimientos mal hechos
 - un montaje no acorde con las presentes instrucciones
 - modificaciones del producto efectuadas por el usuario
- cuidados inadecuados para preservar la calidad de la madera
Desastres naturales o efectos cuasi-catastróficos.

No se aceptarán reclamaciones por cambios de matices, agrietamientos, desviaciones o alteraciones similares que son normales en la madera.

Las reclamaciones por piezas dañadas o defectuosas deben realizarse antes del montaje, dado que de lo contrario queda invalidado el derecho de garantía.

Antes de empezar el montaje deberá tener a mano las siguientes herramientas.

Cinta métrica
enrollable

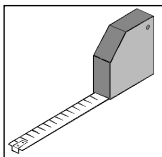

Lápiz

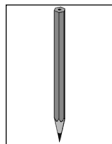

Taladradora

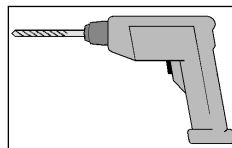

Destornillador eléctrico

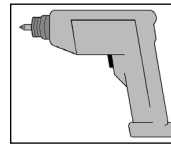

Llave de tuerca

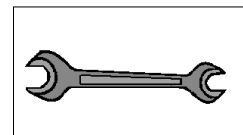

Sierra de dentado fino /
Sierra circular de mano

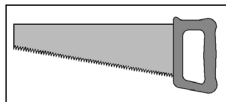

Cortador universal

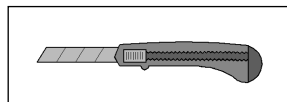

Martillo

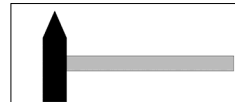

Nivel de burbuja

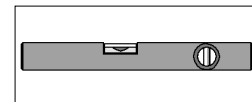

Abreviaturas:

CT	-	casa de tablonos
PF	-	pared frontal
H1	-	altura de cimiento, casa de tablonos
H2	-	altura de cimiento, alero
C25/30	-	hormigón C25/30
TE	-	terreno estable
aprox.	-	aproximadamente
cm	-	centímetros
OKF	-	Borde superior de los cimientos



Caro cliente,
parabéns por ter escolhido um produto weka.

Antes de proceder à montagem, leia o presente manual de instruções na íntegra, por forma a evitar erros de montagem ou danos.

IMPORTANTE!

Com base na lista da embalagem, verifique de imediato se o sub-telhado está completo e se não apresenta danos.

Conserve a lista da embalagem até o período de garantia expirar. Esta lista serve para verificar se as peças individuais se encontram completas e deverá ser guardada juntamente com o talão de compra. Esta lista permite ainda a resolução imediata de eventuais reclamações. Os números de posição da lista da embalagem não coincidem com os das seguintes instruções de montagem.

Recomendamos que a montagem seja efectuada por duas pessoas.

Deve manter as crianças afastadas do local durante a montagem, a fim de evitar acidentes.

Reservamo-nos o direito a futuros desenvolvimentos no âmbito do progresso tecnológico.

Por conseguinte, podem ocorrer desvios menores nas figuras.

Fure previamente todas as uniões roscadas por forma a evitar danos nas peças de madeira!

Ao longo do presente manual de instruções, o seguinte símbolo chamará a sua atenção para esta necessidade:

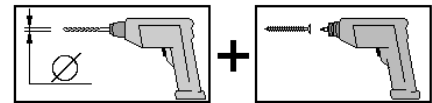

Indicações relativas à montagem na casa

As fundações para os postes devem ser preparadas alguns dias antes da montagem do sub-telhado de acordo com o plano de fundações (página 3).

Deve efectuar a montagem da casa de tábuas em bloco de acordo com as instruções de montagem que se encontram no conjunto de montagem da casa. Antes de colocar os triângulos da empena da casa, comece com a montagem do sub-telhado de acordo com estas instruções de montagem.

O material de fixação para a ancoragem das bases de apoio não faz parte do volume de entrega. As bases de apoio são ajustáveis em altura, para mais tarde se poder ajustar o sub-telhado ao eventual assentamento da casa.

O papelão de cobertura fornecido serve, em primeiro lugar, como protecção temporária contra influências climatéricas. Para poder garantir uma protecção permanente, recomendamos-lhe a cobertura de telhado *apenas* com telhas asfálticas areadas. Deste modo, construirá as bases para uma grande durabilidade e capacidade de resistência contra as influências climatéricas. De outra forma, o seu produto weka corre o risco de se danificar.

Protecção da madeira

O produto é composto por matéria-prima natural, neste caso, a madeira. Isto torna obrigatoriamente necessário que sejam tomadas com regularidade medidas de preservação da madeira. Para um tratamento adequado de preservação da madeira, dirija-se a um especialista da área.

A tomada de medidas de preservação da madeira é da responsabilidade do cliente. Não é concedida garantia no caso de não ser efectuada uma preservação da madeira de acordo com as medidas regulamentadas. Tenha também em atenção as nossas condições de garantia a este respeito.

Esperamos que se divirta com o seu produto de madeira.

Garantia

Concedemos uma garantia abrangente sobre o tratamento posterior adequado e o funcionamento impecável. (de acordo com os nossos termos de garantia) Dentro do período de garantia, todas as peças defeituosas serão substituídas gratuitamente. Os custos decorrentes da substituição não são cobertos pela garantia.

A garantia poderá apenas ser concedida mediante a apresentação da lista da embalagem original e do talão de compra original.

Não estão abrangidos pela garantia os defeitos com as seguintes causas:

fundações e bases inadequadas

montagem não efectuada de acordo com as nossas instruções de montagem

alterações voluntariamente implementadas no produto

tratamento deficiente com vista à manutenção da qualidade da madeira

catástrofes naturais ou qualquer outro tipo de motivos de força maior.

Em caso de alterações da cor, formação de fendas, deformações ou alterações similares, normais em madeiras expostas ao ar livre, não existe qualquer fundamento para reclamar a garantia.

As peças individuais danificadas ou com defeitos devem ser alvo de reclamação antes da montagem, caso contrário a garantia perde a validade.

Antes de dar início à montagem, deverá ter à mão as seguintes ferramentas.

Fita métrica com parafusos

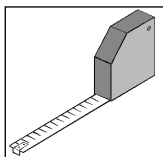

lápiz

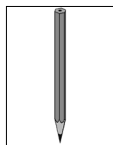

berbequim

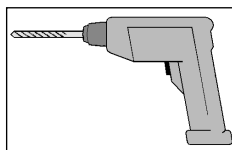

aparafusadora eléctrica

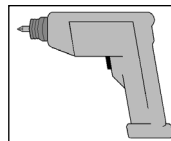

chave de enrolador

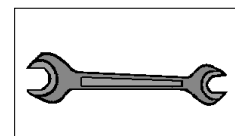

serra fina /
serra circular manual

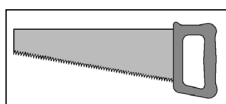

Lâmina universal

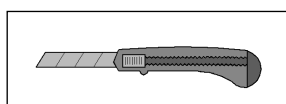

martelo

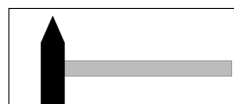

nível de bolha de ar

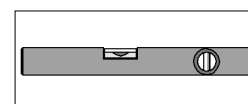

Abreviaturas:

BBH	-	Casa de tábuas em bloco
FW	-	Parede frontal
H1	-	Altura das fundações, casa de tábuas em bloco
H2	-	Altura das fundações, sub-telhado
C25/30	-	Betão C25/30
TB	-	Soalho resistente à carga
aprox.	-	aproximadamente
cm	-	centímetros
OKF	-	Bordo superior da fundação



Tisztelt Vásárló!

Köszönjük, hogy a weka terméket választotta.

A szerelési hibák vagy sérülések elkerülése érdekében összeszerelés előtt olvassa el ezt az útmutatót.

FONTOS!

A csomagolási jegyzék alapján haladéktalanul ellenőrizze, hogy a weka-termék hiánytalanul és sérülésmentesen érkezett-e meg.

A csomagolási jegyzéket csak a garanciális idő letelte után semmisítse meg. Ez a jegyzék az egyes elemek teljességének ellenőrzésére szolgál, és a vásárlási számlával együtt meg kell őrizni. Az esetleges reklamációk ennek a jegyzéknek a segítségével problémamentesen elintézhetőek. A csomagolási jegyzék egyes tételszámai nem egyeznek meg az alábbi szerelési utasítás tételszámaival.

Javasoljuk, hogy ketten végezzék a szerelést.

A balesetek megelőzése érdekében gyermekek ne tartózkodjanak a szerelés közvetlen közelében.

A műszaki haladás érdekében végzett továbbfejlesztések jogát fenntartjuk.

Ezért az ábrákon kisebb eltérések mutatkozhatnak.

A faelemek sérülésének elkerülése érdekében fúrjon elő minden csavarkötést!

Az útmutatóban a következő jel szintén figyelmezteti

Önt erre:

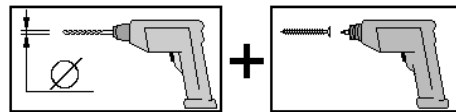

Szerelés és az épület

Az oszlopok alapozását néhány nappal az előtető szerelése előtt az alapozási tervnek megfelelően (3. oldal) el kell készíteni.

A gerendaház összeszerelését a házépítési rendszerhez mellékelt szerelési útmutató alapján végezze. A házhoz tartozó oromháromszög felhelyezése előtt szerelje fel az előtetőt az ebben a szerelési útmutatóban foglaltak szerint.

A támasztólábak lerögzítésének rögzítő anyaga nem tartozik a szállítmányhoz.

A támasztólábak magassága állítható, hogy az előtető később a ház süllyedésének megfelelően illeszthető legyen.

A házzal együtt szállított tetőlemez elsősorban ideiglenes védelemként szolgál az időjárási Behatásokkal szemben. A gerendaház tartós védelmének biztosítására azt javasoljuk, hogy a tetőt *csak* üveghomokkal beszórt bitumenzsindelyekkel fedje be. Ez hosszú távú tartósságot és az időjárással szembeni ellenállást biztosít az épületnek. Ellenkező esetben károsodhat az Ön által vásárolt weka-termék.

Favédelem

A termék fából, vagyis természetes alapanyagból készült. A fa azonban rendszeresen kielégítő védelmet igényel. A szakszerű favédelemmel kapcsolatos tudnivalóért kérjük, forduljon favédelmi szakemberhez.

A favédelmi intézkedéseket az ügyfelek saját felelősségükre végzik. Előírászerű favédelem hiányában nem áll módunkban garanciát vállalni. Kérjük, figyelmesen olvassa el az erre vonatkozó feltételeket jótállási nyilatkozatunkban.

Sok örömet kívánunk Önnek új fatermékéhez.

Garancia

A szakszerű további feldolgozásra és a kifogástalan működésre átfogó garanciát adunk. (a garanciális feltételeinknek megfelelően). A hibás elemeket garanciaidőn belül ingyen kicseréljük. A csere miatt keletkező költségeket nem tartalmazza a garancia.

A garanciaigények csak az eredeti csomagolási jegyzékkel és vásárlási számlával együtt érvényesíthetők.

A garancia nem vonatkozik azokra a hiányosságokra, amelyek az alábbiak miatt keletkeztek:
szakszerűtlen aljzatok és alapozások
nem ennek az útmutatónak megfelelően elvégzett szerelés
a termék sajátkezű megváltoztatása
a fennálló faminőség fenntartása érdekében végzett hibás ápolás
természeti katasztrófák vagy más erőszakos hatások.

Színváltozás, repedések képződése, vetemedés vagy más hasonló elváltozások, amelyek szabadban lévő faanyagoknál normálisnak tekintendők, nem képezik reklamáció alapját.
A sérült vagy meghibásodott alkatrészeket a beépítés előtt kell megkifogásolni, mivel ellenkező esetben megszűnik a garanciaigény.

A következő szerszámokat készítse elő a szerelés megkezdése előtt.

Mérőszalag

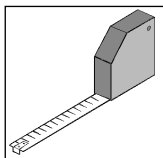

Ceruza

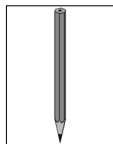

Fúrógép

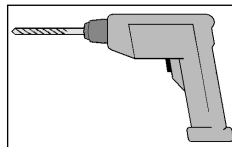

Elektromos csavarhúzó

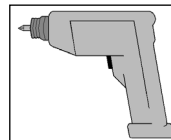

Csavarkulcs

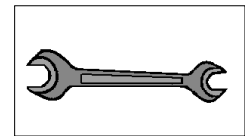

Finomfűrész

Kézi körfűrész

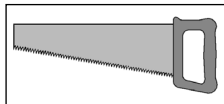

Univerzális kés

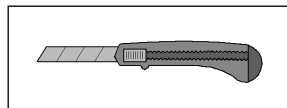

Kalapács



Vízmérték

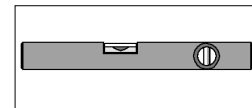

Rövidítések:

BBH	-	Faház
FW	-	Elülső fal
H1	-	Alapozás magassága, blokkház
H2	-	Alapozás magassága, előtető
C25/30	-	Beton, C25/30
TB	-	teherhordó padló
kb.	-	Kb.
cm	-	centiméter
OKF	-	Az alapozás felső széle



Geachte klant,

Wij zijn u erkentelijk dat u voor een product van weka hebt gekozen.

Lees deze handleiding vóór de montage helemaal om montagefouten of beschadigingen te vermijden.

BELANGRIJK!

Controleer direct aan de hand van de paklijst of de luifel volledig en onbeschadigd bij u is aangekomen.

Vernietig de paklijst pas na afloop van de garantieperiode. Deze lijst is voor de controle op volledigheid van alle onderdelen en moet met de kassabon worden bewaard. Eventuele reclames kunnen met behulp van deze lijst probleemloos worden opgelost. De pos.-nummers van de paklijst komen niet overeen met de pos.-nummers van de volgende montagehandleiding.

Wij adviseren de montage met 2 personen uit te voeren.

Om ongevallen te voorkomen, moet worden vermeden dat kinderen zich tijdens de montage in de directe nabijheid bevinden.

Ontwikkelingen in de zin van technische vooruitgang behouden wij ons voor.

Op deze wijze kunnen kleine afwijkingen in de afbeeldingen ontstaan.

Boor alle schroefverbindingen voor om beschadiging van de houten delen te voorkomen.

Het volgende symbool maakt u in de handleiding nogmaals hierop opmerkzaam:

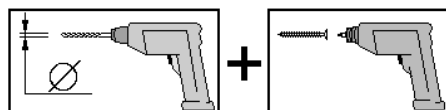

Aanwijzingen voor de montage aan het huis

De funderingen voor de palen moeten een paar dagen voor de montage van de luifel worden gemaakt volgens de aanwijzingen in het funderingsplan (pagina 3)

Monteer het blokhuis volgens de montagehandleiding die bij de bouwset is meegeleverd. Voordat u het fronton op het huis plaatst, begint u met de montage van de luifel volgens de aanwijzingen in deze montagehandleiding.

Het bevestigingsmateriaal voor het verankeren van de steunvoeten is niet inbegrepen in de levering.

De steunvoeten kunnen in hoogte worden versteld, zodat de luifel kan worden bijgesteld bij eventuele verzakkingen van het huis.

Het meegeleverde dakvielt dient in eerste instantie als tijdelijke bescherming tegen weersinvloeden.

Om voor een duurzame bescherming te zorgen adviseren wij u de dakbedekking *alleen* met bezande bitumenshingles te gebruiken. Daarmee legt u de basis voor een lange duurzaamheid en resistentie tegen weersinvloeden. Anders valt schade aan uw weka-product niet uit te sluiten.

Houtbescherming

Het product bestaat uit de natuurlijke grondstof hout. Dit maakt het noodzakelijk regelmatig voldoende maatregelen uit te voeren om het hout te beschermen. Voor een vakkundige beschermende behandeling van het hout dient u zich tot een deskundige op het gebied van houtbescherming te wenden.

Maatregelen voor de bescherming van het hout moeten door de klant voor eigen verantwoordelijkheid worden uitgevoerd. Zonder bescherming van het hout volgens voorschrift kan geen garantie worden geboden. Neem ook onze garantiebepalingen dienaangaande in acht. Wij wensen u veel plezier met uw houten product.

Garantie

Op de vakkundige verwerking en de probleemloze werking van onze producten verlenen wij een uitgebreide garantie. (Zie onze garantiebepalingen). Binnen de garantieperiode worden onderdelen met gebreken gratis vervangen. De kosten van vervanging behoren niet tot de garantie. Aanspraak op garantie kan uitsluitend in combinatie met de originele paklijst en de originele kassabon worden behandeld.

Uitgesloten van garantie zijn gebreken die veroorzaakt zijn door:
verkeerde funderingen
montage die niet volgens deze handleiding is uitgevoerd
eigen veranderingen aan het product
verkeerde behandeling voor conservering van het hout
natuurrampen of gebruik van geweld

Kleurveranderingen, scheurvorming, vervorming of soortgelijke veranderingen die normaal zijn bij hout in de buitenlucht, zijn geen reden voor reclames.
Evt. reclames over beschadigde of defecte onderdelen dient u voor het monteren te melden, omdat u anders geen recht hebt op garantie.

Het volgende gereedschap moet u vóór het begin van de montage gereed hebben liggen.

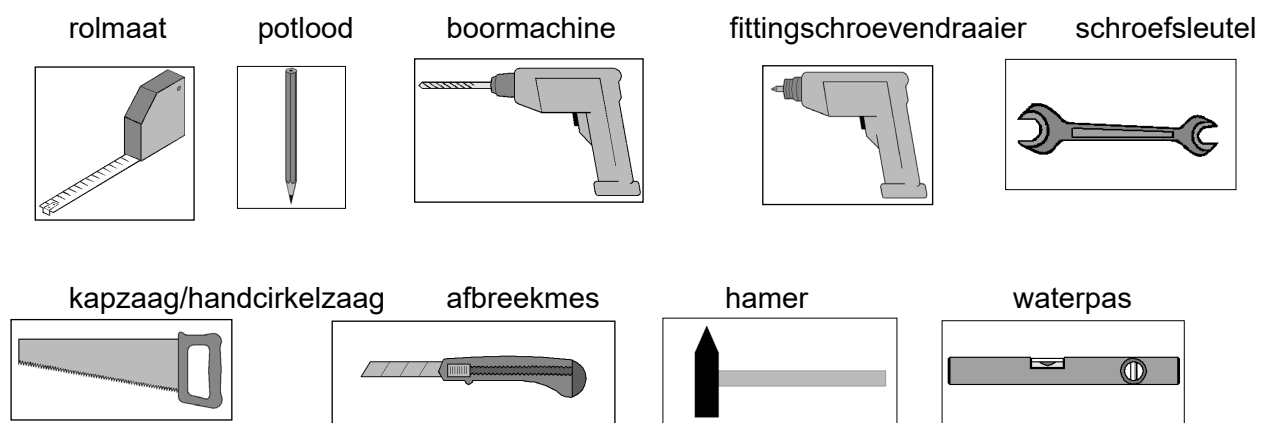

Afkortingen:	BBH	-	blokhuis
	FW	-	frontwand
	H1	-	funderingshoogte, blokhuis
	H2	-	funderingshoogte, luifel
	C25/30	-	beton C25/30
	TB	-	belastbare bodem
	ca.	-	circa
	cm	-	centimeter
	OKF	-	bovenkant fundering



Poštovane klijentice, poštovani klijenti,
zahvaljujemo se što ste se odlučili za weka proizvod.

Prije postavljanja pažljivo pročitajte ove upute kako biste prilikom montaže izbjegli pogreške ili oštećenja.

VAŽNO!

Odmah provjerite prema popisu pakiranja je li weka proizvod stigao do vas kompletan i neoštećen.

Uništite popis pakiranja tek nakon isteka jamstvenog roka. Taj popis služi kao kontrola potpunosti pojedinih dijelova i potrebno ga je sačuvati zajedno s računom o kupnji. Eventualne se reklamacije pomoću tog popisa mogu riješiti bez problema. Brojevi pozicija (stavki) popisa pakiranja ne odgovaraju brojevima pozicija u sljedećoj uputi za montažu.

Preporučujemo da montažu izvedu 2 osobe.

Kako biste izbjegli nezgode, zabranite pristup djeci za vrijeme montaže.

Zadržavamo pravo na daljnji razvoj u smislu tehničkog poboljšanja.

Stoga može doći do malih odstupanja u prikazima.

Sve vijčane spojeve prethodno izbušite kako biste spriječili oštećenja na drvenim dijelovima!

Sljedeći znak u uputama skreće vam dodatno
Pozornost na to:

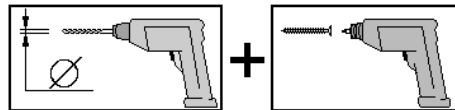

Savjeti za montažu kod kuće

Temelje potporna valja nekoliko dana prije montaže nadstrešnice izraditi prema nacrtu temelja (stranica 3).

Montažu kućice od blokova greda potrebno je obaviti sukladno uputama za montažu koje se isporučuju uz proizvod. Prije nego što postavite zabatne trokute kućice, obavite montažu nadstrešnice u skladu s ovim uputama za montažu.

Materijal za pričvršćivanje sidara nosača ne spada u obim isporuke.

Visina nosača je podesiva kako bi se kasnije, u slučaju slijeganja kuće, nadstrešnica mogla prilagoditi novom položaju kuće.

Isporučeni krovni karton u prvom redu služi za privremenu zaštitu od vremenskih utjecaja. Kako bi se osigurala dugotrajna zaštita, preporučujemo pokrivanje krova *samo* pjeskarenom bitumenskom šindrom. Na taj ćete način stvoriti temelj za dugu trajnost i otpornost na vremenske utjecaje. U suprotnom može doći do oštećivanja Vašeg proizvoda tvrtke weka.

Zaštita drva

Proizvod je izrađen od prirodnog drveta. Zbog toga su nužne redovite i odgovarajuće mjere zaštite drveta. Informacije o profesionalnoj zaštiti drveta zatražite od stručnjaka u zaštiti drveta.

Mjere zaštite drveta kupac provodi na vlastitu odgovornost. U slučaju neprovođenja pravilne zaštite drveta ne preuzimamo nikakvu odgovornost. Pregledajte odredbe našeg jamstva koje se odnose na ovo pitanje.

Želimo Vam mnogo zadovoljstva pri korištenju Vašeg proizvoda od drveta.

Jamstvo

Profesionalnu obradu i besprijekorno funkcioniranje zajamčeni su našim opsežnim jamstvom. (sukladno našim jamstvenim uvjetima) neispravni se dijelovi unutar jamstvenog roka besplatno zamjenjuju. Troškovi nastali uslijed zamjene nisu uključeni u jamstveni zahtjev. Jamstveni zahtjevi se uvažavaju samo uz originalni popis pakiranja i račun izdan prilikom kupnje.

Od jamstva su izuzeti nedostaci koji su nastali zbog:
nepropisnih temelja i postavljanja
montaže koja nije provedena prema ovim uputama
vlastitih izmjena na proizvodu
neispravne njege za očuvanje postojeće kvalitete drveta
prirodnih katastrofa ili drugih nasilnih utjecaja.

U slučaju promjene boje, stvaranja pukotina, deformacija i sličnih promjena, koje su normalne kada se drvo nalazi na otvorenom nema osnove za reklamaciju. Oštećeni ili neispravni dijelovi moraju se reklamirati prije ugradnje jer u suprotnom jamstvo ne važi.

Prije početka montaže potrebno je pripremiti sljedeći alat.

Metalni metar

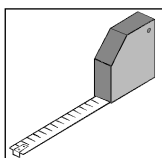

Olovka

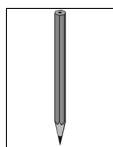

Bušilica

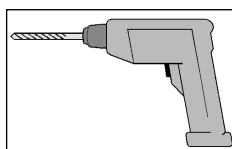

Električni odvijač

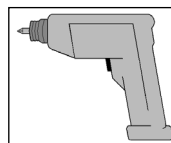

Francuski ključ

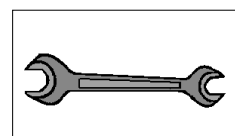

Pila sa sitnim zupcima /
Ručna kružna pila

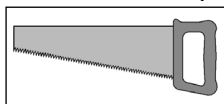

Skalpel

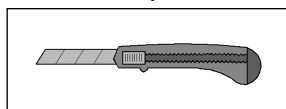

Čekić

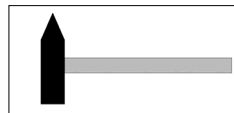

Libela

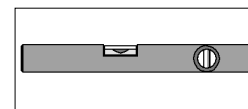

Kratice:

BBH	-	Kučica od blokova greda:
FW	-	Prednji zid
H1	-	Visina temelja, kuća od blokova greda
H 2	-	Visina temelja, nadstrešnica
C25/30	-	Beton C25/30
TB	-	Nosivi pod
ca.	-	približno
cm	-	centimetar
OKF	-	Gornji rub temelja

Spoštovani kupec,

zahvaljujemo se vam za nakup izdelka weka.

Pred montažo natančno preberite ta navodila, da se izognete napakam ali poškodbam pri montaži.

POZOR!

Po priloženem seznamu preverite, ali ste prejeli vse dele nadstreška in če ti niso poškodovani. Priloženi seznam delov zavržite šele po poteku garancije. V pomoč vam bo pri preverjanju posameznih delov in ga hranite skupaj z računom. Morebitne pritožbe je mogoče brez težav odpraviti s pomočjo tega seznama delov. Točke seznama se ne ujemajo s točkami navodil za montažo.

Priporočamo vam, da montažo izvedeta dve osebi.

Da bi preprečili morebitne nesreče, se otroci v času montaže ne smejo nahajati v neposredni bližini. Pridružujemo si pravico do sprememb zaradi izboljšav.

Zato lahko pride pri prikazih do manjših odstopanj.

Da se izognete poškodbam lesenih delov, vse navojne spoje pripravite s predvrtanjem!

V navodilih vas na to ponovno opozori naslednji znak:

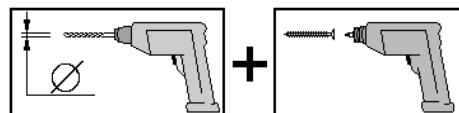
**Napotki za hišno montažo**

Temelje za stebre pripravite v skladu z načrtom temeljev (stran 3) nekaj dni pred montažo nadstreška.

Brunarico sestavite v skladu z navodili za izgradnjo, ki so priložena v obsegu dobave kompleta za izgradnjo. Nadstrešek je treba v skladu s temi navodili namestiti pred samo namestitvijo čelnih polj hiše.

Pritrdila za pritrditev podpornikov niso priložena.

Podporniki so višinsko nastavljivi, da lahko pozneje nadstrešek prilagodite morebitnemu usedanju hiše.

Dobavi priložena strešna lepenka služi v prvi vrsti kot prehodna zaščita proti vremenskim vplivom.

Če želite zagotoviti trajno zaščito, priporočamo strešno kritino s *samo* peskanimi bitumenskimi skodlami. S tem boste dobili podlago za dolgo življenjsko dobo in odpornost proti vremenskim vplivom. V nasprotnem primeru lahko pride do poškodb vaših izdelkov weka.

Zaščita lesa

Izdelek je iz naravne surovine, lesa. Zato so redni, zadostni ukrepi za zaščito lesa nujno potrebni.

Za strokovno zaščitno obdelavo lesa se obrnite na strokovnjaka za les.

Ukrepe za zaščito lesa morajo stranke izvesti na lastno odgovornost. Brez predpisane zaščite lesa ne moremo priznati garancije. Prosimo, upoštevajte tudi s tem povezana določila v naši garancijski izjavi.

Z lesnim izdelkom vam želimo mnogo veselja.

Garancija

Za strokovno nadaljnjo obdelavo in brezhibno delovanje vam nudimo obsežno garancijo (v skladu z našimi garancijskimi določili). V času garancije bomo poškodovane dele zamenjali brezplačno.

Stroškov, ki nastanejo z zamenjavo, garancija ne pokriva.

Garancijo lahko uveljavljate samo ob predložitvi seznama delov in računa.

Garancija ne pokriva napak, ki so nastale zaradi:
slabih temeljev in postavitve le-teh,
montaže, ki ni bila izvedena v skladu s temi navodili,
lastnih sprememb izdelka,
pomanjkljive nege za ohranitev obstoječe kakovosti lesa,
naravnih nesreč ali druge višje sile.

Spremembe barve, razpoke, izkrivljenje in podobne spremembe, ki so pri lesu na prostem običajen pojav, niso razlog za reklamacijo.

Poškodovane ali okvarjene dele pred vgradnjo reklamirajte, sicer garancijske pravice ne bodo veljavne.

Pred začetkom montaže si pripravite naslednje orodje:

tračni meter

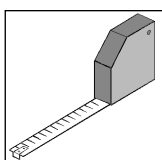

svinčnik

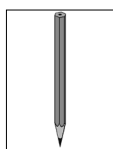

vrtalnik

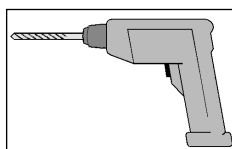

električni izvijač

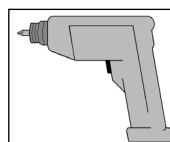

viličasti ključ

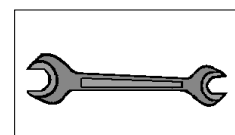

fina žaga/
ročna krožna žaga

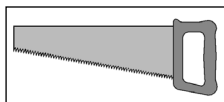

alfa nož

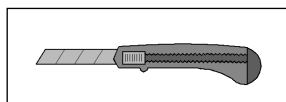

kladivo

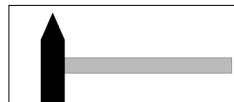

libela

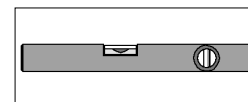

Okrajšave:

BBH	-	brunarica
FW	-	sprednja stena
H1	-	višina temelja, brunarica
H2	-	višina temelja, nadstrešek
C25/30	-	beton C25/30
TB	-	nosilnost tal
pribl.	-	približno
cm	-	centimetri
OKF	-	Cena ne vključuje stroškov za izgradnjo temeljev

Fundament

GB	Foundation	E	Cimientos	NL	Fundering
F	Fondation	P	Fundação	HR	Temelj
I	Fondamenta	H	Alap	SLO	Temelj

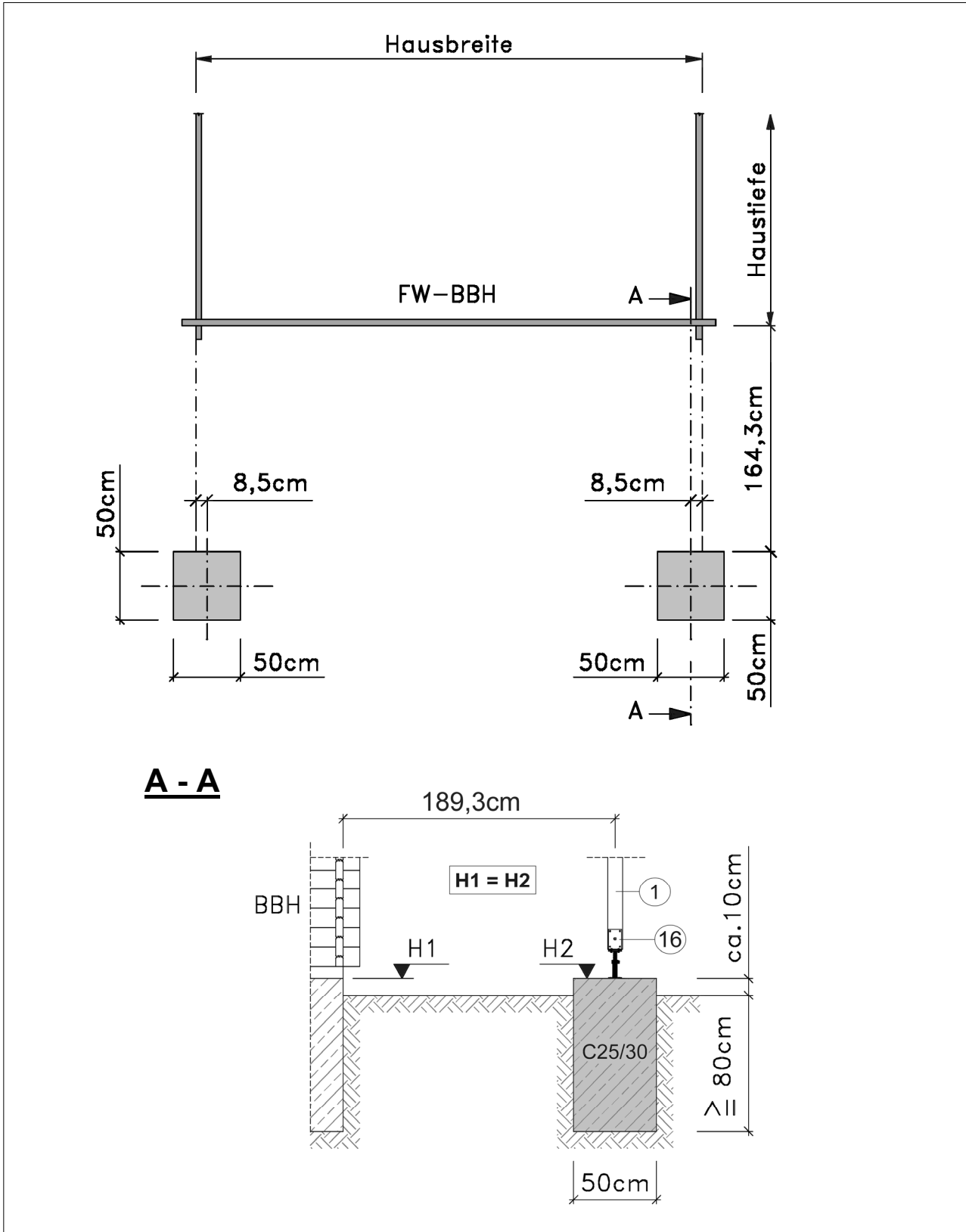



Stückliste

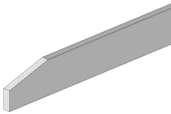
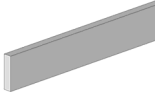
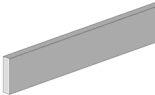

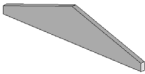
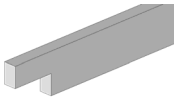
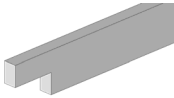
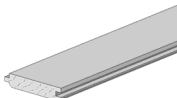
GB	Parts list	E	Lista de piezas	NL	onderdelenlijst
F	liste des pièces	P	Lista de peças	HR	popis dijelova
I	lista pezzi	H	darabjegyzék	SLO	lista kosov

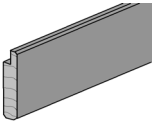
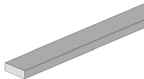
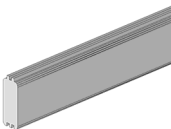
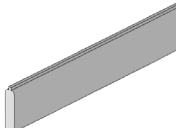
Pos	Bild	Land	Benennung	Abmessung	Stück	
					100.1814.34	100.1814.38
①		D	Kreuzholzpfosten	80 / 80 / 2200	2	2
		GB	Quartered timber stud			
		F	Poteau carré en bois			
		I	Montante in legno a quarto di tronco			
		E	Poste de madera cortada en cruz			
		P	Pilar de madeira cortada em cruz			
		H	Keresztfá			
		NL	Paal van kwartiershout			
		HR	Stup s klinastim spojem			
		SLO	Podboj zagozde			
②		D	Querpfette	18,5 / 96 / 1672 18,5 / 96 / 1872	2 -	- 2
		GB	Cross purlin			
		F	Panne transversale			
		I	Arcareccio trasversale			
		E	Cabio transversal			
		P	Terça transversal			
		H	Szelemen			
		NL	Dwarsgording			
		HR	Poprečna greda			
		SLO	Prečna lega			
③		D	Glattkantbrett	18,5 / 96 / 1540	1	1
		GB	Smooth edge board			
		F	planche à bord lisse			
		I	asse a bordo liscio			
		E	Tabla de cantos lisos			
		P	Tábua esquadriada lisa			
		H	sima szélű deszka			
		NL	plank met afgeronde hoeken			
		HR	glatka rubna daska			
		SLO	gladka robna deska			
④		D	Windfeder	18,5 / 96 / 2250 18,5 / 96 / 2405	2 -	- 2
		GB	Bargeboard			
		F	ressort pare-vent			
		I	molla a vento			
		E	Lengüeta cortavientos			
		P	Tábua pára-vento			
		H	széldeszka			
		NL	windveer			
		HR	letvica za umetanje			
		SLO	vetrno pero			

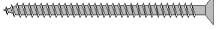
Pos	Bild	Land	Benennung	Abmessung	Stück	
					100.1814.34	100.1814.38
5		D	Verbindungsplasche	18,5 / 146 / 700	1	1
		GB	Splice plate			
		F	Couvre-joint			
		I	Piastra di giunzione			
		E	Brida de unión			
		P	Cobrejunta de ligação			
		H	Összekötő heveder			
		NL	Klamp			
		HR	Spojna latica			
		SLO	Spojna zaplata			
6		D	Mittelpfette	45 / 146 / 1472	2	2
		GB	Purlin			
		F	panne			
		I	arcareccio			
		E	Cabio			
		P	Caibro; Madre			
		H	szelemen			
		NL	gording			
		HR	krovna greda			
		SLO	lega			
7		D	Firstpfette	45 / 146 / 1453	1	1
		GB	Purlin			
		F	panne			
		I	arcareccio			
		E	Cabio			
		P	Caibro; Madre			
		H	szelemen			
		NL	gording			
		HR	krovna greda			
		SLO	lega			
8		D	Hobelbrett	18,5 / 121 / 2200 18,5 / 121 / 2350	25 -	- 25
		GB	Plane board			
		F	planche rabotée			
		I	asse da falegname			
		E	Tabla de cepillo			
		P	Tábua aplainada			
		H	gyalult deszka			
		NL	geschaafde plank			
		HR	daska za blanjanje			
		SLO	skobelna deska			

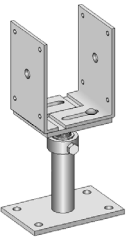
Pos	Bild	Land	Benennung	Abmessung	Stück	
					100.1814.34	100.1814.38
9		D	Traubrett	18,5 / 96 / 1400	2	2
		GB	Fascia board			
		F	frise			
		I	asse di gronda			
		E	Alero			
		P	Tábua de beiral			
		H	ereszdeszka			
		NL	gootlijst			
		HR	daska strehe			
		SLO	kapna deska			
10		D	Deckleiste	11 / 58 / 2040	2	2
		GB	Ceiling batten			
		F	latte de recouvrement			
		I	listello di copertura			
		E	Listo tapajuntas			
		P	Cobrejunta			
		H	takaróléc			
		NL	dekljist			
		HR	stropna letvica			
		SLO	stropna letev			
11		D	Wandbohle	45 / 121 / 1957	2	2
		GB	Wall board			
		F	madrier de paroi			
		I	tavola da parete			
		E	Tablón de pared			
		P	Prancha de parede			
		H	faldeszka			
		NL	wandplank			
		HR	zidna daska			
		SLO	stenska deska			
12		D	Wandbohle D	28 / 121 / 1949	2	2
		GB	Wall board			
		F	madrier de paroi			
		I	tavola da parete			
		E	Tablón de pared			
		P	Prancha de parede			
		H	faldeszka			
		NL	wandplank			
		HR	zidna daska			
		SLO	stenska deska			

Pos	Bild	Land	Benennung	Abmessung	Stück	
					100.1814.34	100.1814.38
13		D	Schraube	6,0 x 150	20	20
		GB	Screw			
		F	vis			
		I	vite			
		E	Tornillo			
		P	Parafuso			
		H	csavar			
		NL	schroef			
		HR	vijak			
		SLO	vijak			
14		D	Schraube	5,0 x 80	20	20
		GB	Screw			
		F	vis			
		I	vite			
		E	Tornillo			
		P	Parafuso			
		H	csavar			
		NL	schroef			
		HR	vijak			
		SLO	vijak			
15		D	Schraube	3,5 x 35	100	100
		GB	Screw			
		F	vis			
		I	vite			
		E	Tornillo			
		P	Parafuso			
		H	csavar			
		NL	schroef			
		HR	vijak			
		SLO	vijak			
16		D	U-Pfostenträger, verstellbar	100 / 100 / 290	2	2
		GB	Support foot			
		F	béquille			
		I	pie de appoggio			
		E	Pie de apoyo			
		P	Base de apoio			
		H	támasztóláb			
		NL	steunvoet			
		HR	potporna noga			
		SLO	podporna noga			

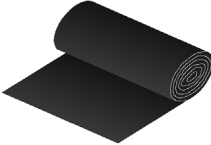
Pos	Bild	Land	Benennung	Abmessung	Stück	
					100.1814.34	100.1814.38
17		D	U-Scheibe	6,4mm	6	6
		GB	Plain washer			
		F	rondelle			
		I	rondella			
		E	Arandela			
		P	Anilha plana			
		H	csavaralátét			
		NL	onderlegplaatje			
		HR	podložna pločica			
		SLO	podložka			
		18				
GB	Wire nail					
F	pointe					
I	spina in filo metallico					
E	Punta de París					
P	Prego de cabeça chata					
H	drótszeg					
NL	draadnagel					
HR	čavao					
SLO	Žičniki					
19				D	Dachpappstift	2,0 x 16
		GB	Tack			
		F	pointe pour carton bitumé			
		I	spina per cartone catramato			
		E	Espiga para cartón asfáltico			
		P	Prego de cabeça larga			
		H	fedéllemez-szeg			
		NL	asfaltnagel			
		HR	čavao za krovni karton			
		SLO	žebelj za strešno lepenko			
20		D	Dachpappe	10m ²	1	1
		GB	Roof paper			
		F	carton bitumé			
		I	cartone catramato			
		E	Cartón asfáltico			
		P	Papelão da cobertura			
		H	fedéllemez			
		NL	asfaltpapier			
		HR	krovni karton			
		SLO	strešna lepenka			

Aufbauübersicht

GB	Design overview	H	szerkezeti áttekintés
F	Présentation du montage	NL	Montageoverzicht
I	Panoramica di montaggio	HR	Pregled za gradnju
E	Vista estructural	SLO	Pregled izgradnje
P	Panorâmica da estrutura		

D Pos.21 / Pos.22 befinden sich im Hauspaket!

- GB Item 21 / item 22 are included in the cabin pack!
 F Les pos. 21/22 se trouvent dans le colis de l'abri !
 I La pos.21 / pos.22 sono incluse nell'imballaggio della casetta!
 E ¡Las pos.21 / pos.22 se encuentran en el paquete de la casa!
 P Pos. 21/22 encontram-se no pacote da casa!
 H A 21. tétel / 22. tételt a házépítő csomag tartalmazza!
 NL Pos. 21/pos. 22 zitten bij de bouwset van het huis!
 HR Poz. 21/poz. 22 nalaze se u paketu s kućicom!
 SLO Elementa 21 in 22 sta vključena v obseg dobave hiše!

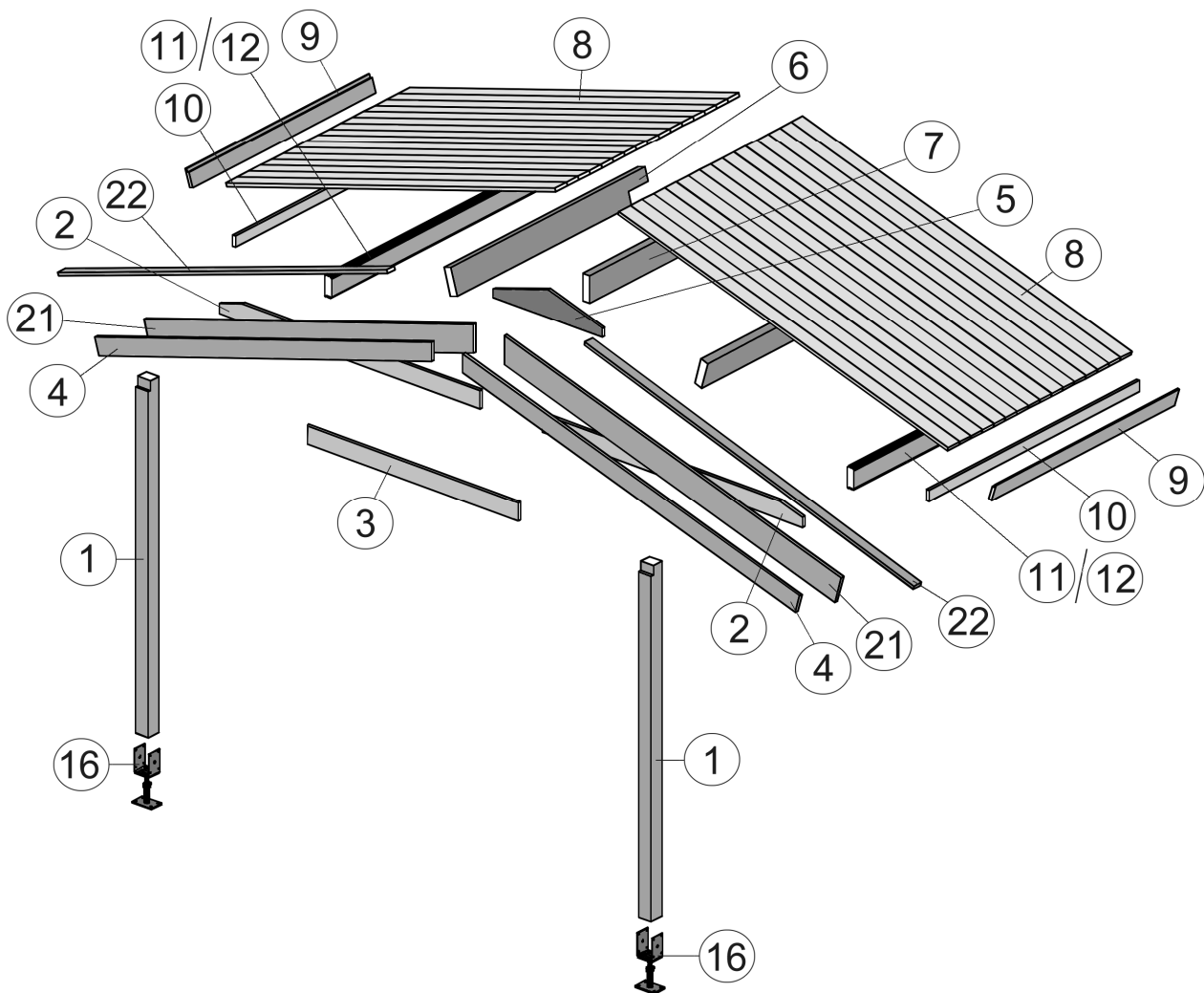

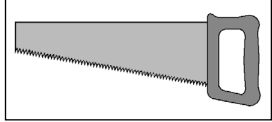
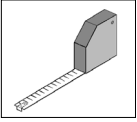

1

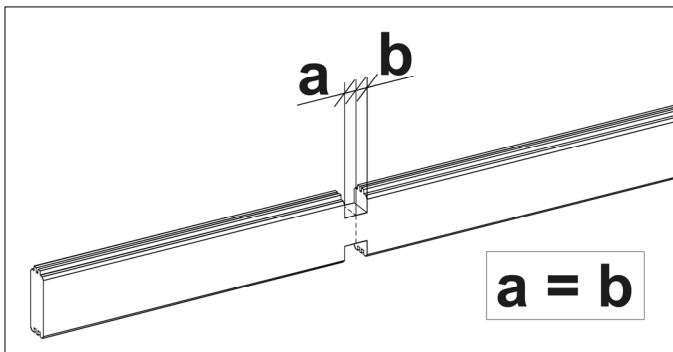
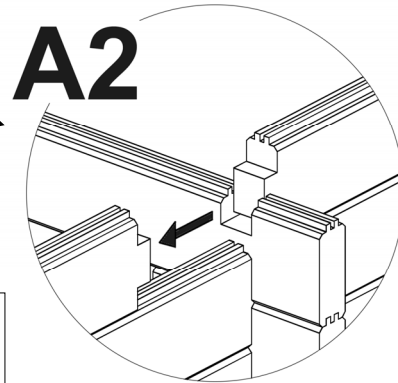
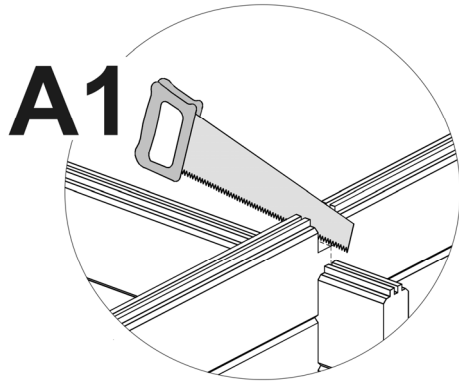
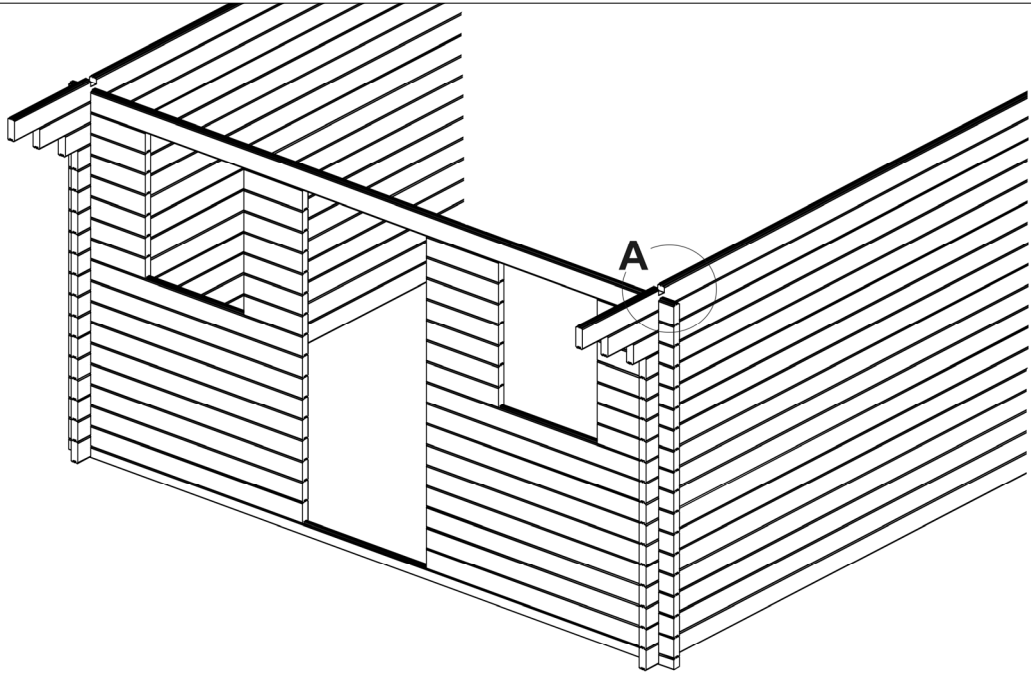

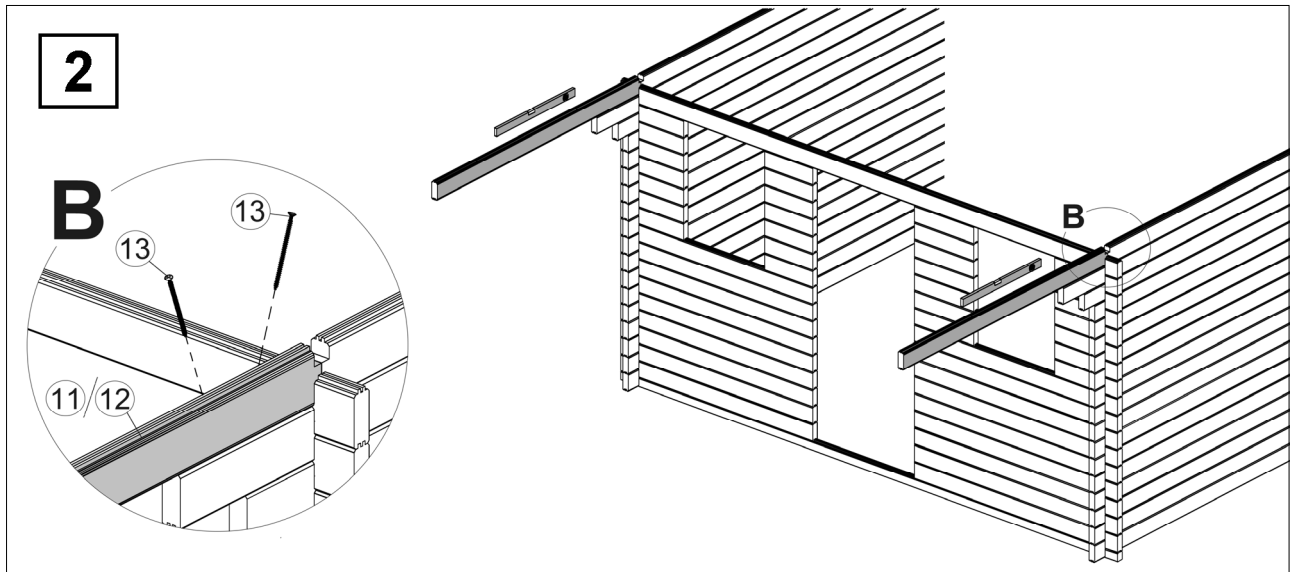
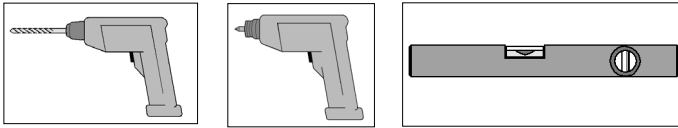

- D** Wird das Vordach an ein Haus mit 45mm Wandstärke montiert verwenden Sie Pos.11, bei 28mm Wandstärke verwenden Sie Pos.12!
- GB** If the roof overhang is to be mounted on a cabin with 45 mm thick walls, use item 11; use item 12 for cabins with 28 mm thick walls.
- F** Si l'avant-toit est monté sur un abri avec une épaisseur de paroi de 45 mm, utilisez la pos. 11, pour une épaisseur de paroi de 28 mm, utilisez la pos. 12 !
- I** Se la pensilina viene montata su una casa con spessore delle pareti di 45mm utilizzate la pos.11, se lo spessore delle pareti è di 28mm utilizzate la pos.12!
- E** Si se monta el alero en una casa con un grosor de pared de 45mm, utilice la pos.11, y para un grosor de pared de 28mm utilice la pos.12.
- P** Se o sub-telhado for montado numa casa com uma espessura de parede de 45 mm, utilize a pos. 11, no caso de uma espessura de parede de 28 mm utilize a pos. 12!
- H** Amennyiben az előtető 45 mm falvastagságú házra kerül felszerelésre, használja a 11. tételt, 28 mm-es falvastagság esetén pedig a 12. tételt!
- NL** Wordt de luifel aan een huis met een wanddikte van 45 mm gemonteerd, gebruik dan pos.11, bij een wanddikte van 28 mm gebruikt u pos. 12!
- HR** Ako se nadstrešnica montira na kućicu debljine zidova od 45 mm, koristite poz. 11. Ako se montira na kućicu debljine zida od 28 mm, koristite poz. 12!
- SLO** Če nadstrešek nameščate na hišo, katere debelina sten je 45 mm, uporabite element 11, pri hišah z debelino sten pa uporabite element 12!

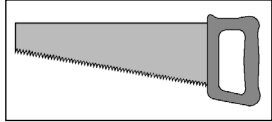
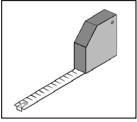

3

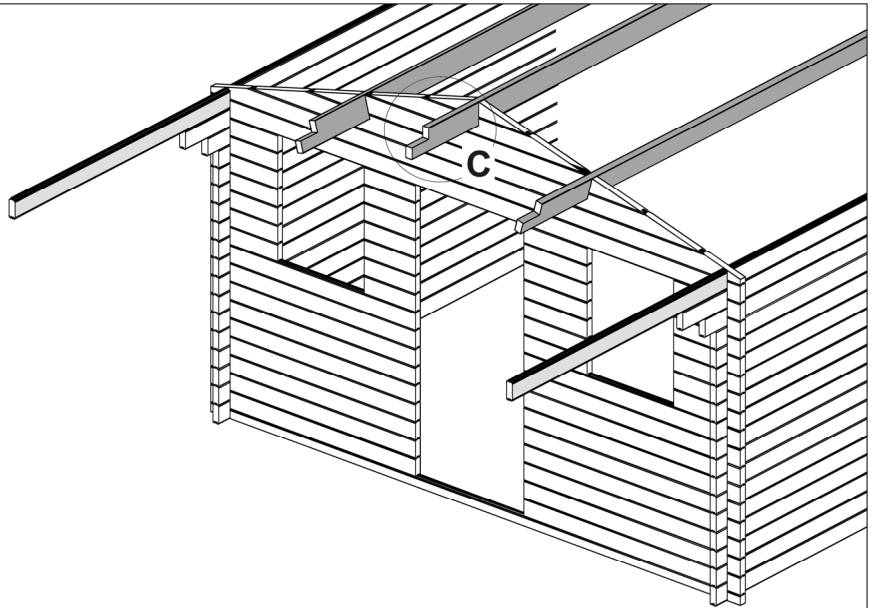

C

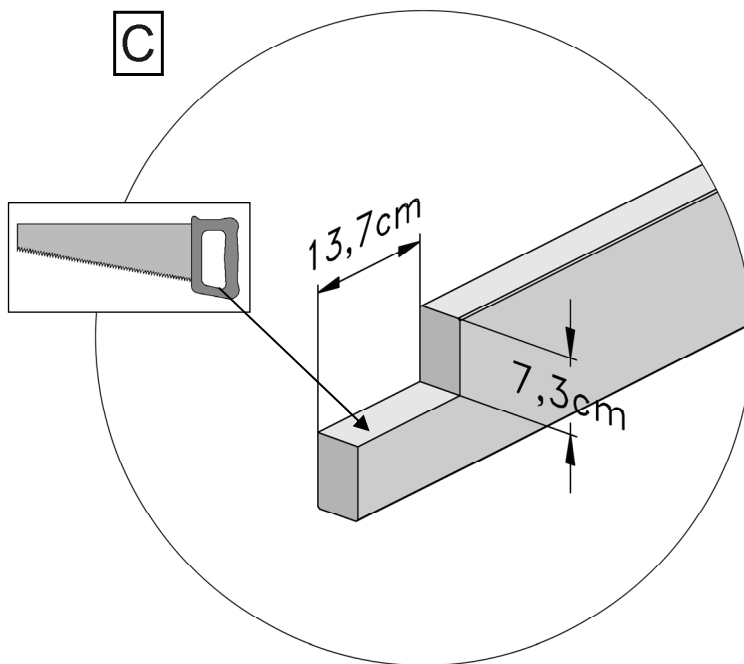

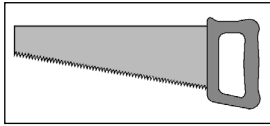
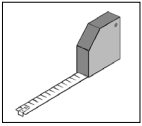

4

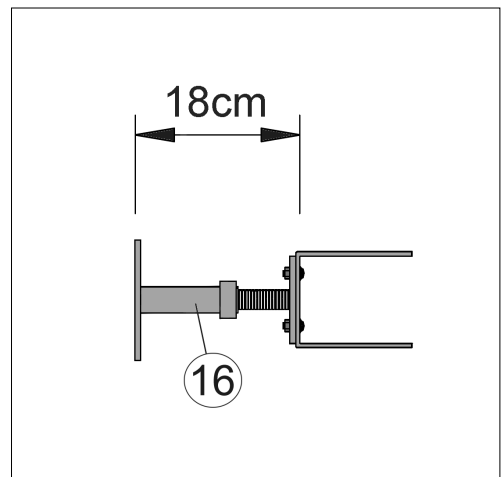
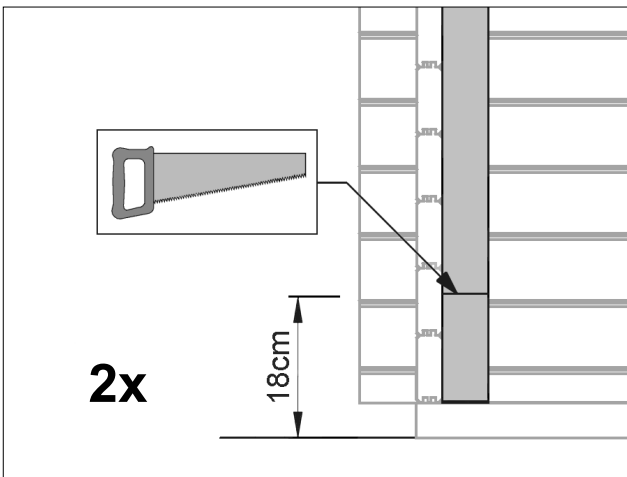
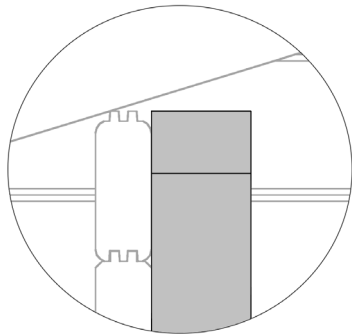
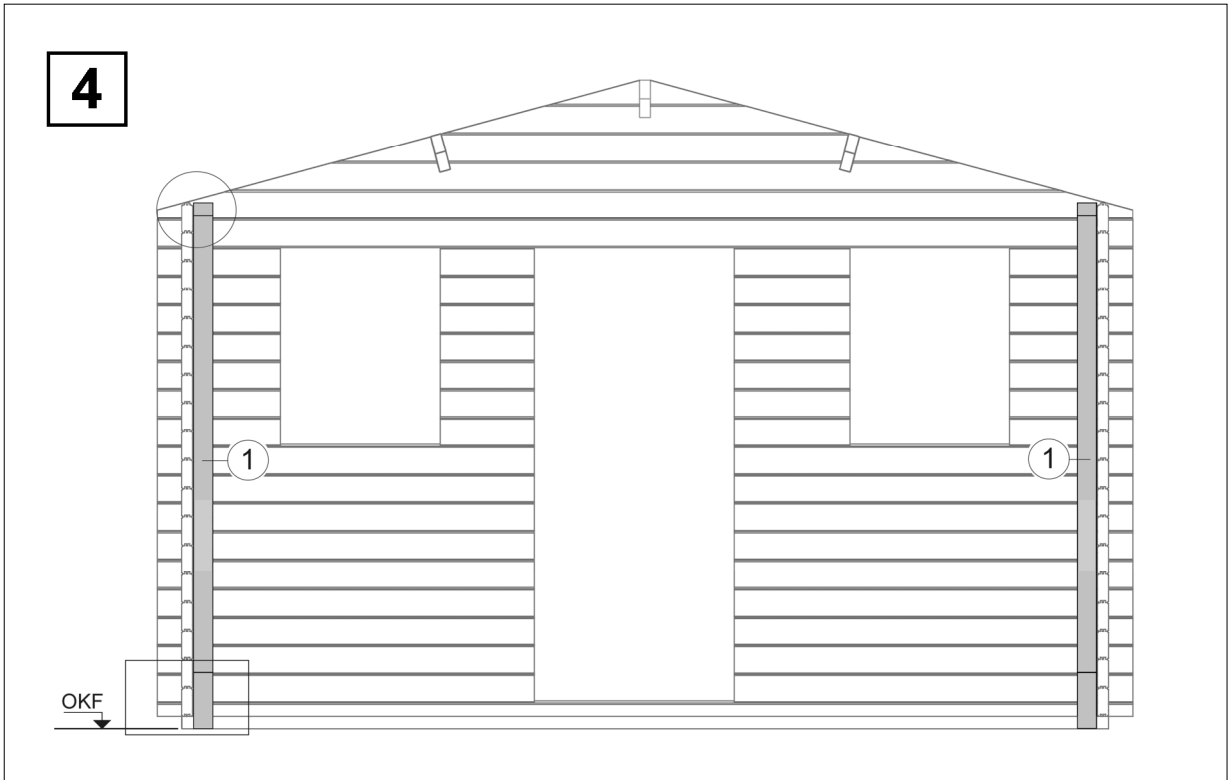

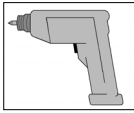
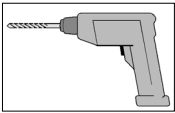

5

2x

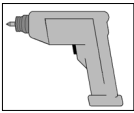
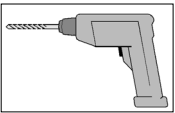
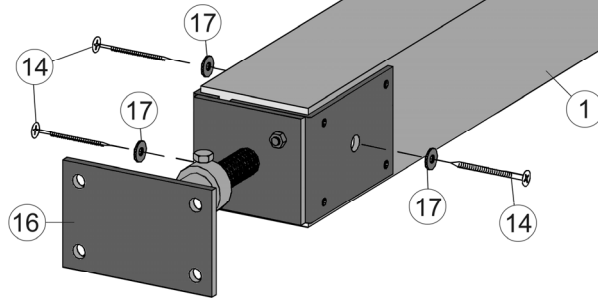

6

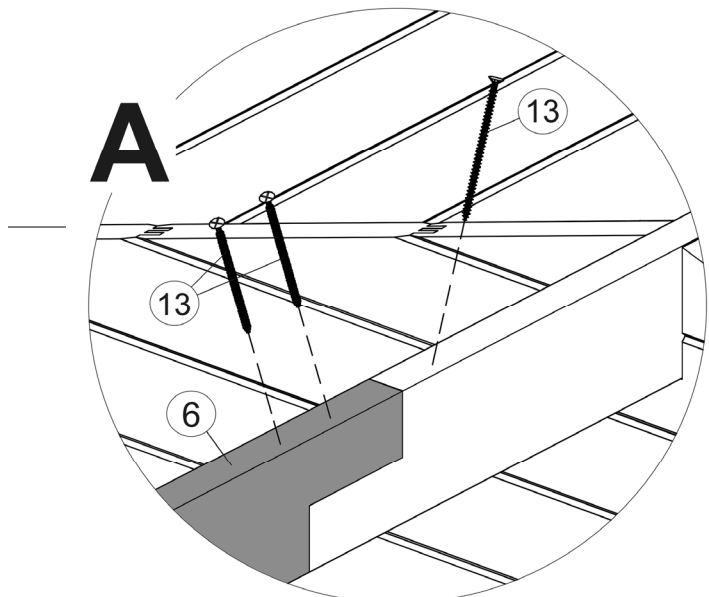
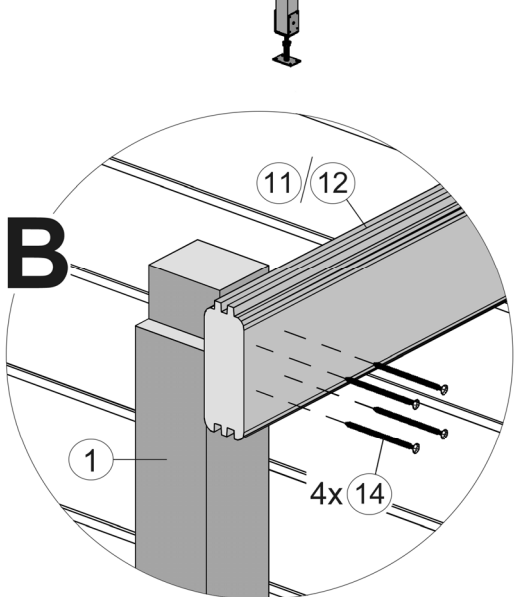
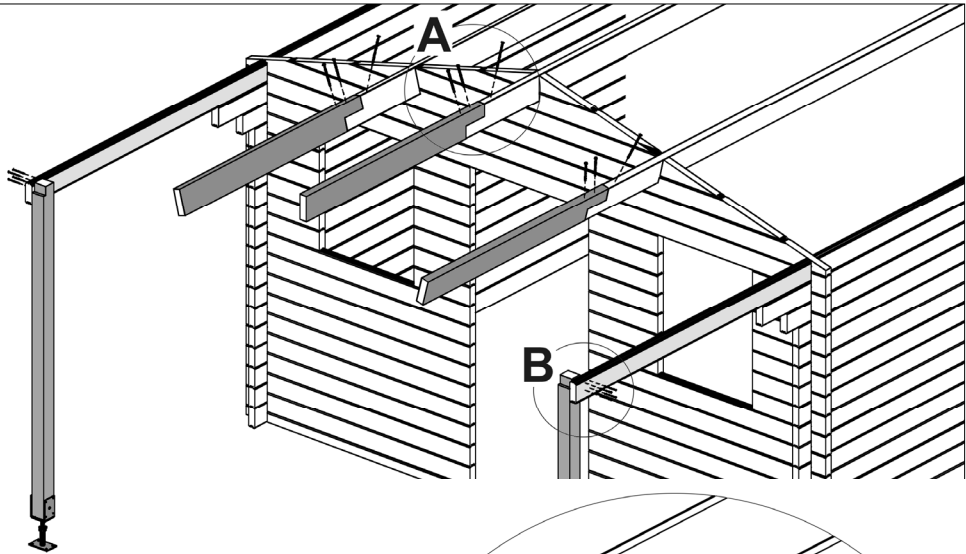

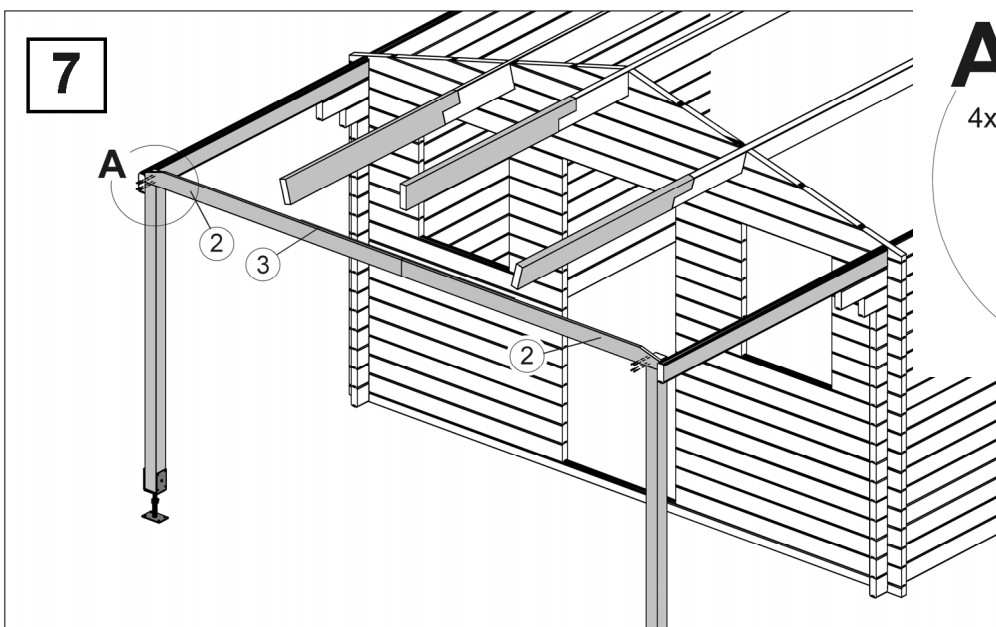
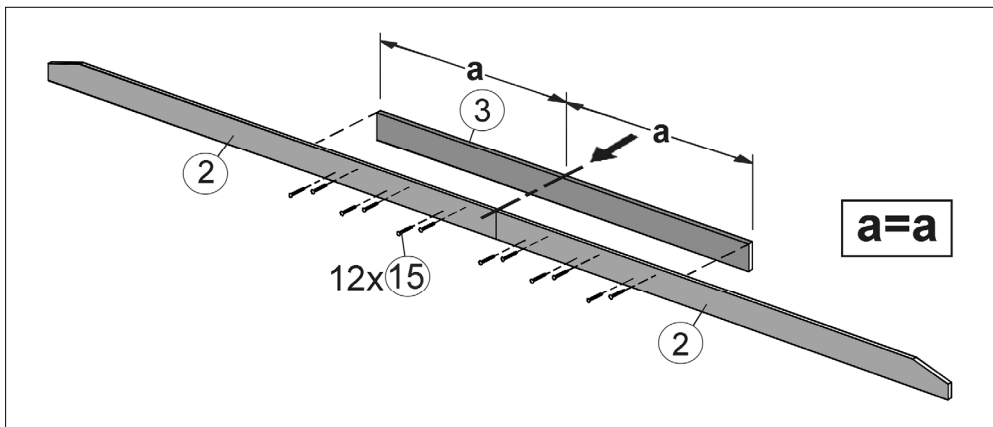
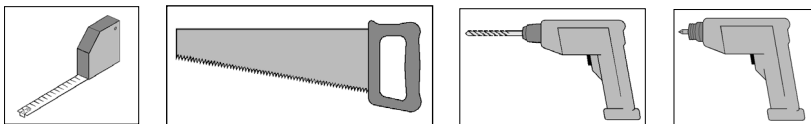

- D** → Bei Wandstärke 45mm bitte die Pos.2 um 1,7cm kürzen!
- GB** → Shorten item 2 by 1.7 cm on both sides for 45 mm thick walls.
- F** → Pour une épaisseur de paroi de 45 mm, veuillez raccourcir la pos. 2 de 1,7 cm des deux côtés !
- I** → In caso di pareti con spessore di 45mm accorciate la pos.2 di 1,7cm su entrambi i lati!
- E** → Si el grosor de la pared es de 45mm, acorte la pos.2 por ambos lados en 1,7cm.
- P** → No caso de uma espessura de parede de 45 mm encurtar a pos. 2 em 1,7 cm dos dois lados!
- H** → 45 mm-es falvastagság esetén a 2. tétel mindkét oldalon rövidítse le 1,7 cm-rel!
- NL** → Bij een wanddikte van 45 mm dient u pos. 2 aan beide zijden 1,7 cm in te korten!
- HR** → Kod debljine zida od 45 mm neophodno je skratiti poz. 2 s obje strane za 1,7 cm!
- SLO** → Pri debelini sten 45 mm je treba element 2 na obeh straneh skrajšati za 1,7 cm!

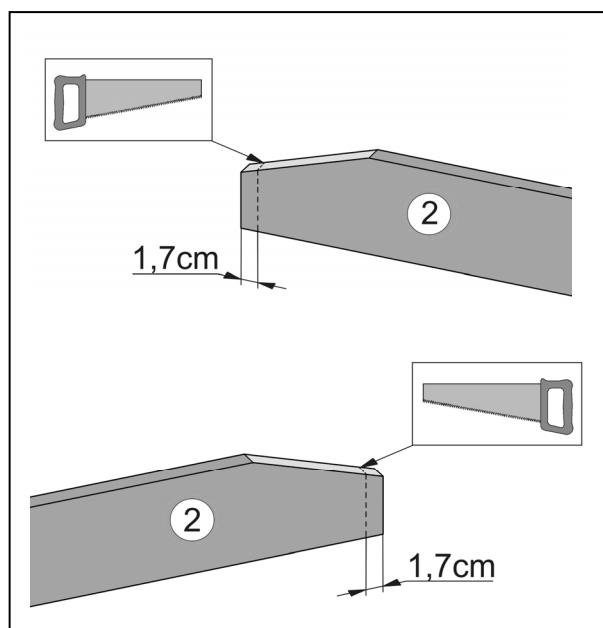

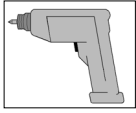
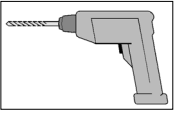

8

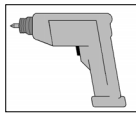
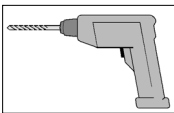
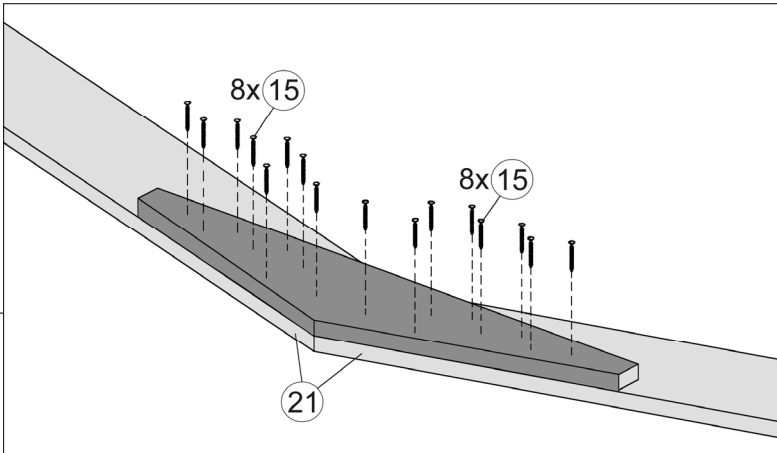
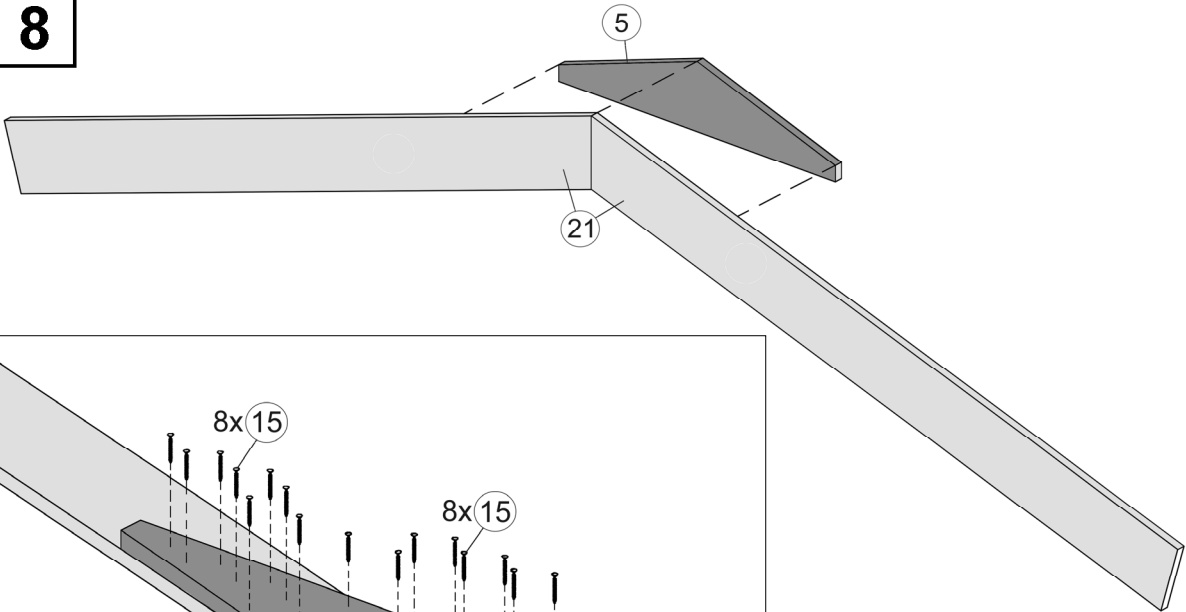

9

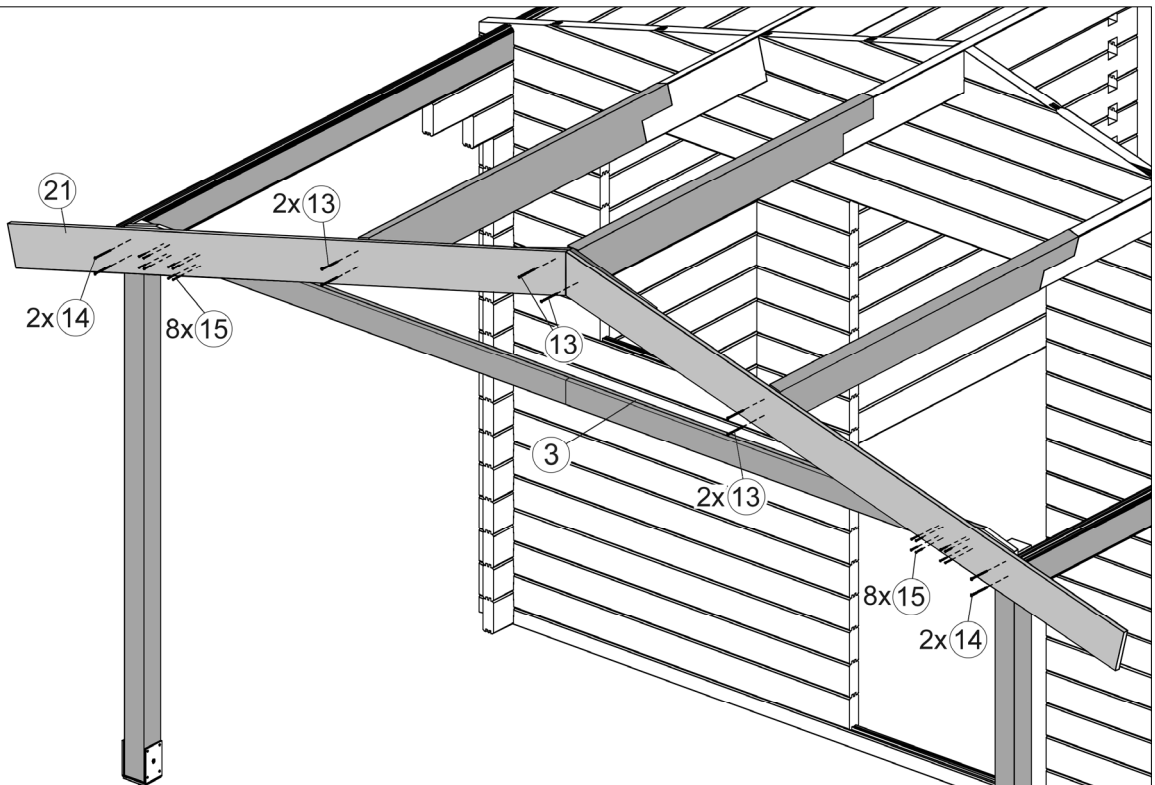

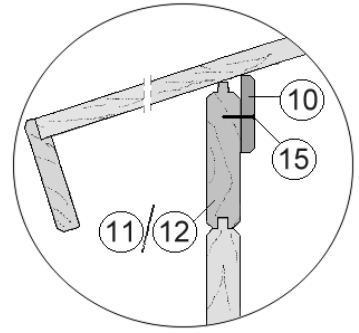
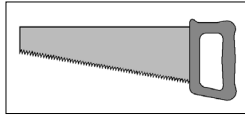
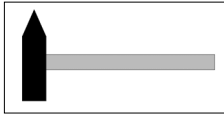
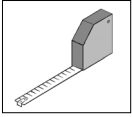

10

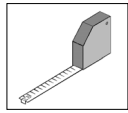
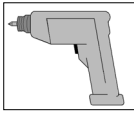
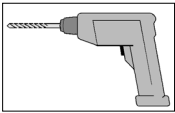
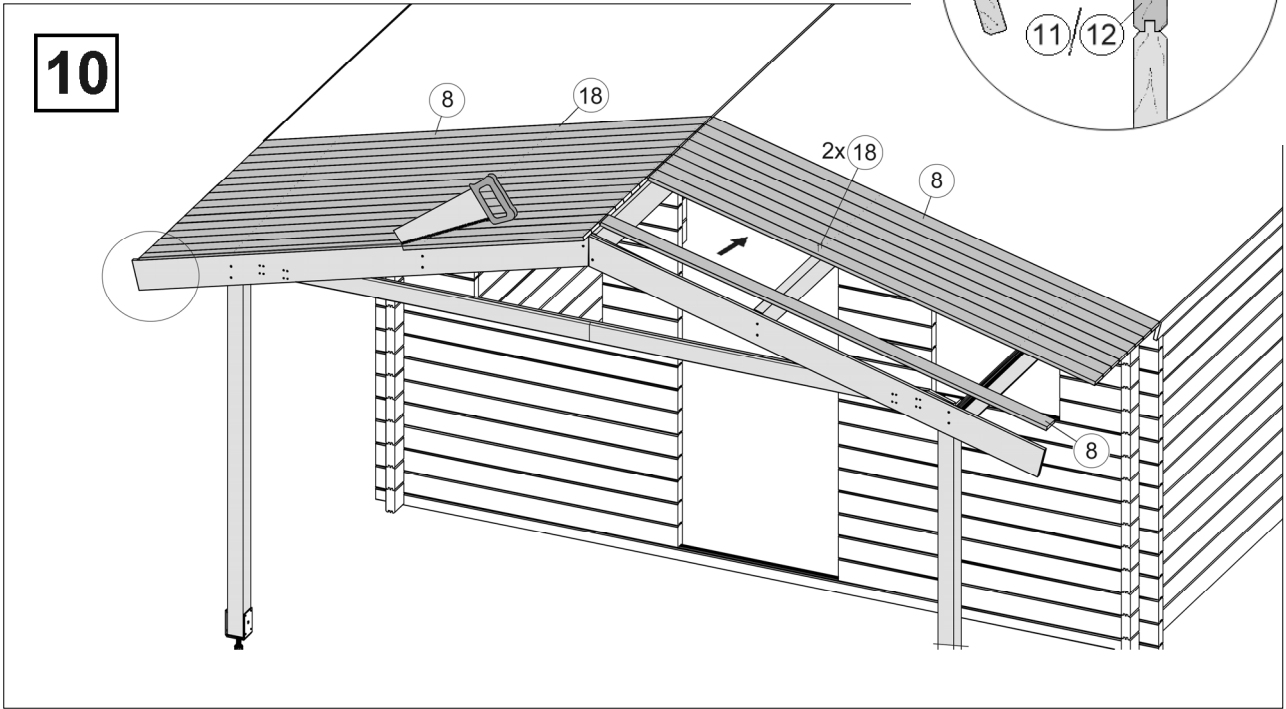

A-A

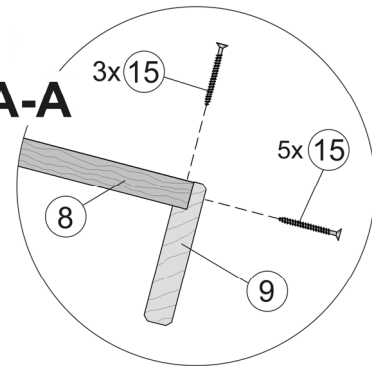

11

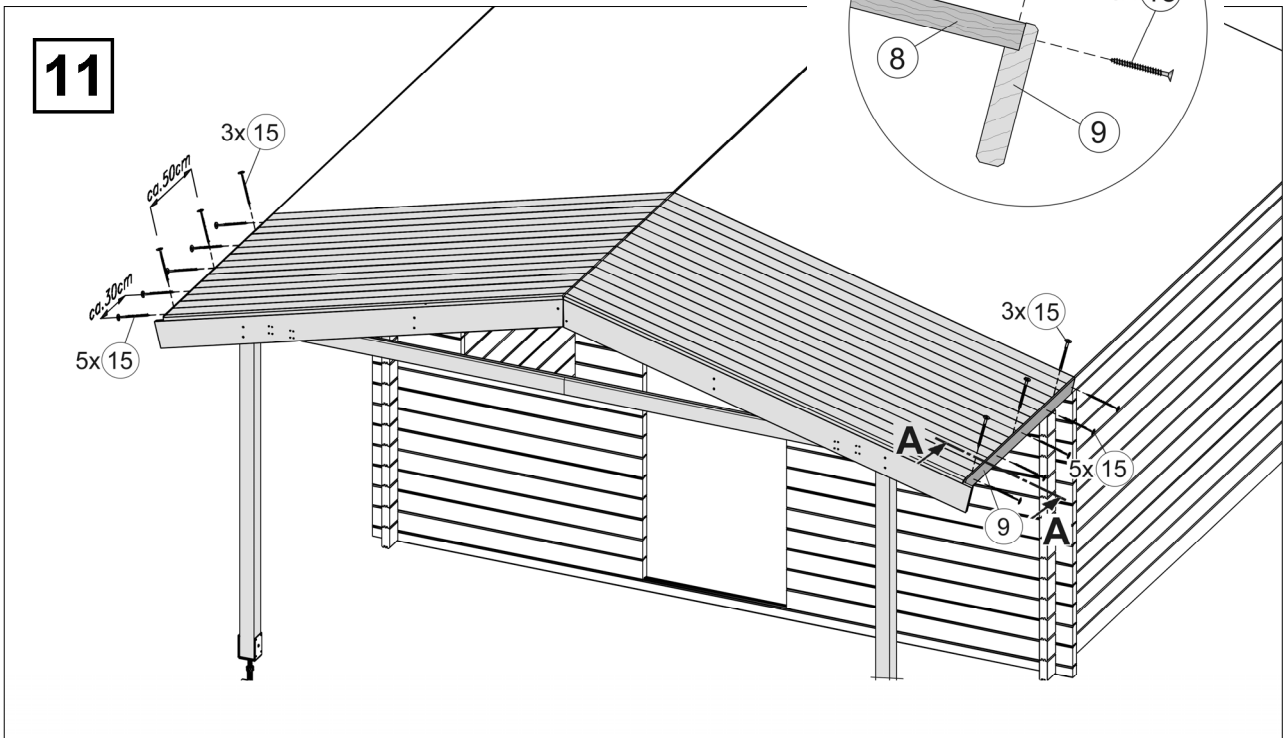

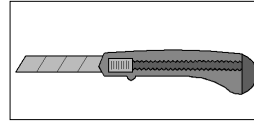
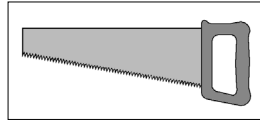
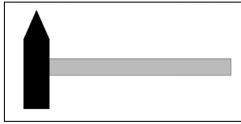
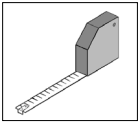

12

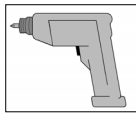
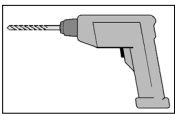
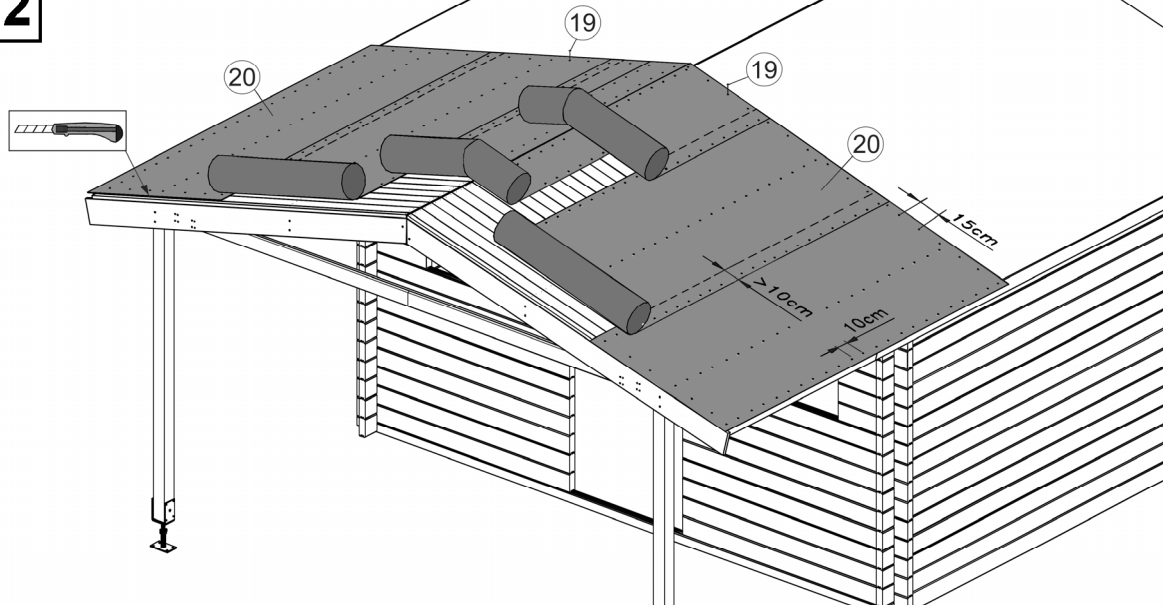

13

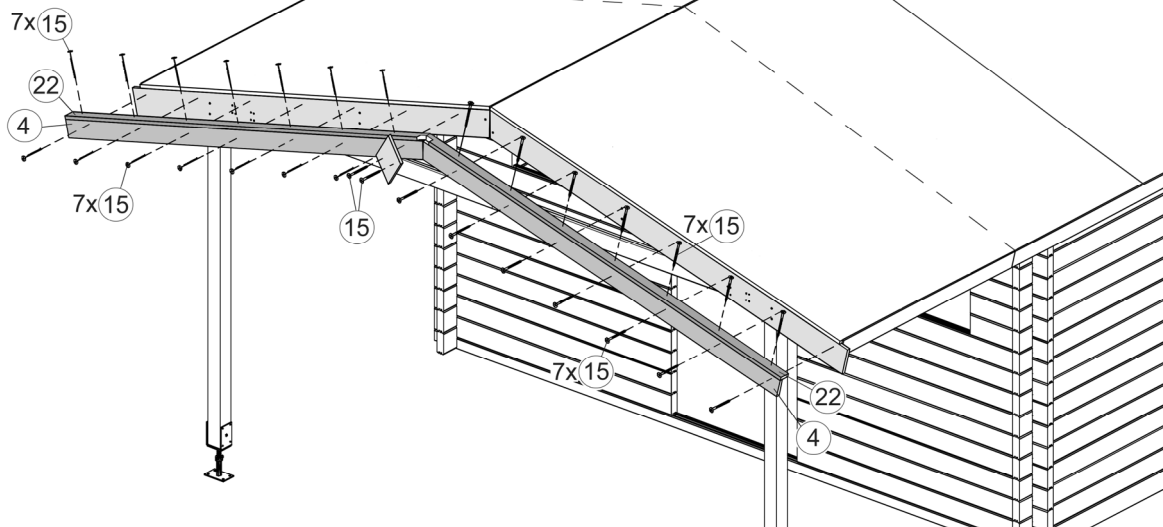

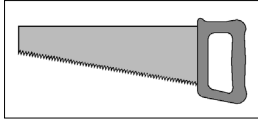
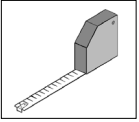

14

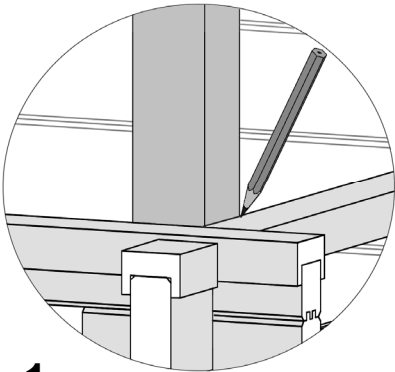
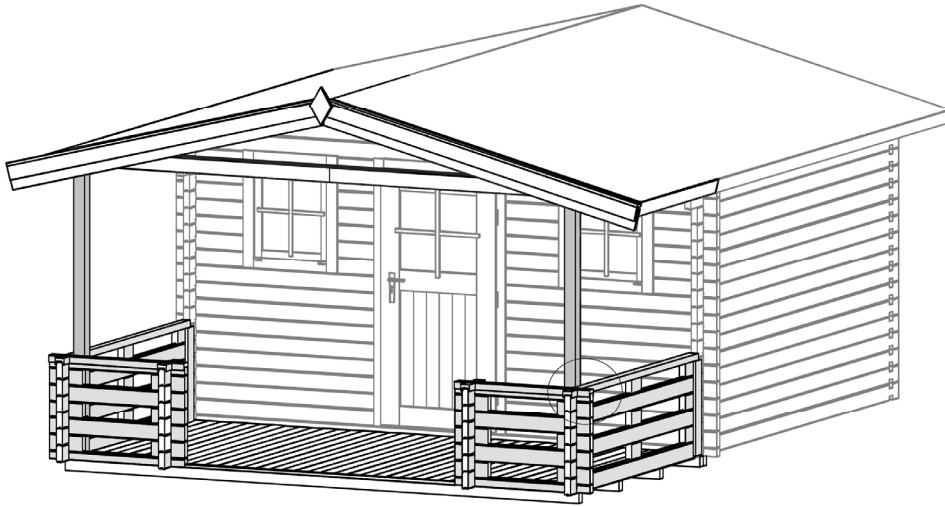

1.

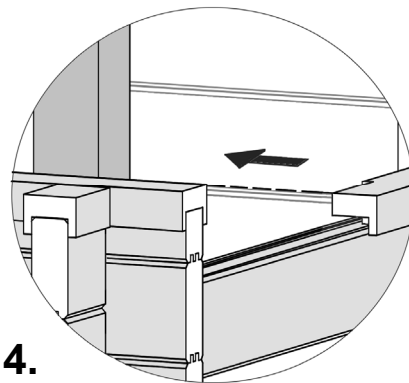

4.

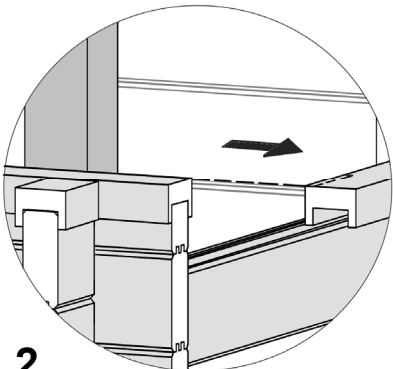

2.

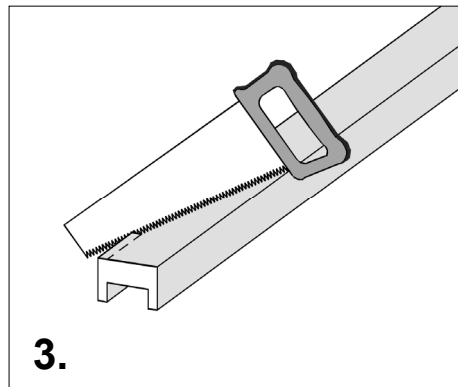

3.



weka Holzbau GmbH,
Johannesstr. 16
D-17034 Neubrandenburg
Tel.: 0395 42908-0
Fax: 0395 42908-83

MA.-Art.-Nr.: 800.0286.00.78