

C-01

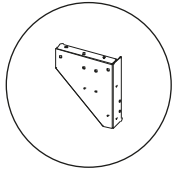

29 x 4

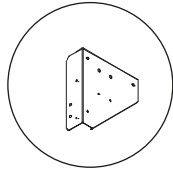

29-1 x 4

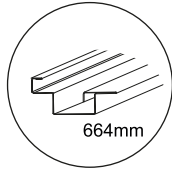

40 x 4  
664mm

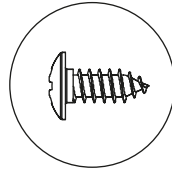

F1 x 32

x4

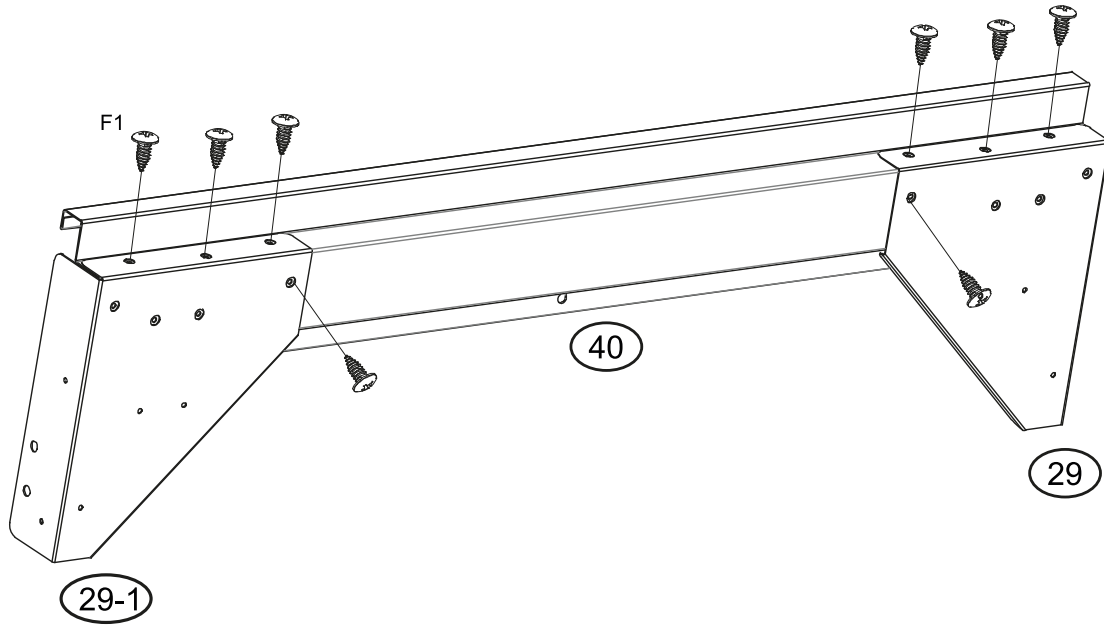

C-02

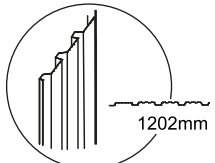

D1 x 1

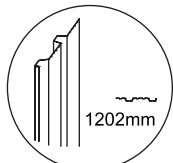

D2 x 1

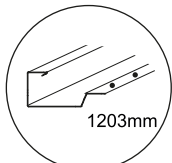

41 x 1

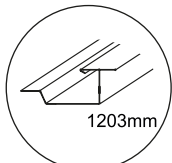

42 x 1

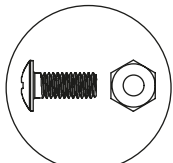

F2 x 3

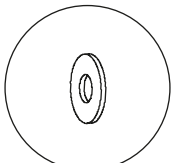

S3 x 3

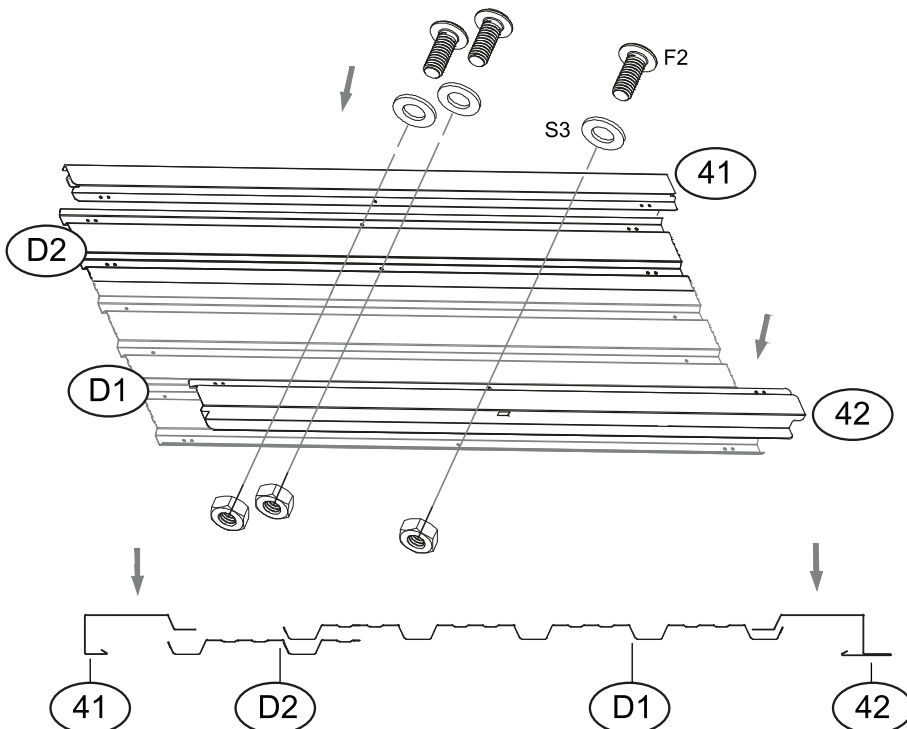

# C-03

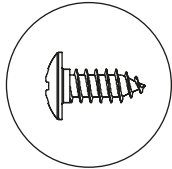

F1 x 14

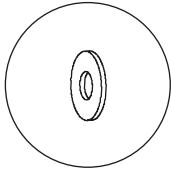

S3 x 18

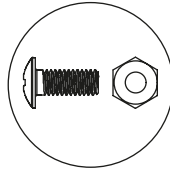

F2 x 4

1

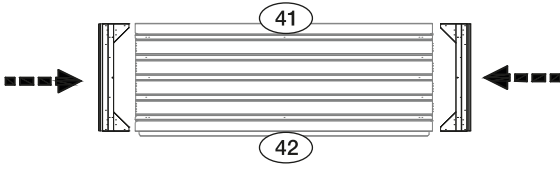

2

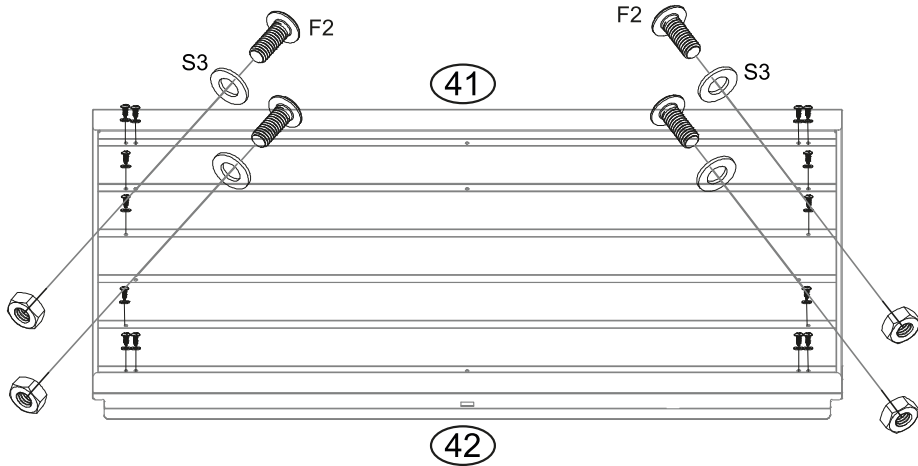
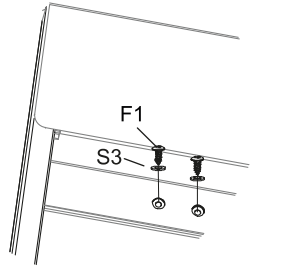

# C-04

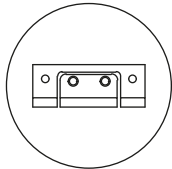

G4 x 2

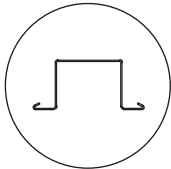

55 x 1

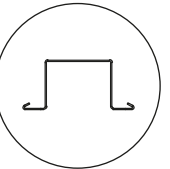

56 x 1

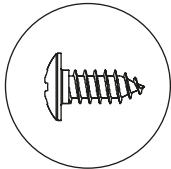

F1 x 16

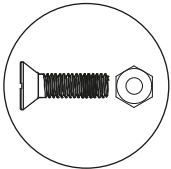

F3 x 4

1

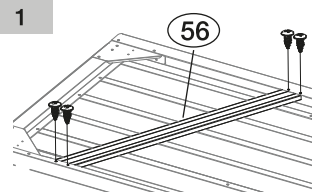

2

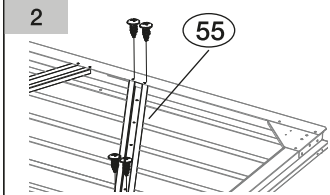

3

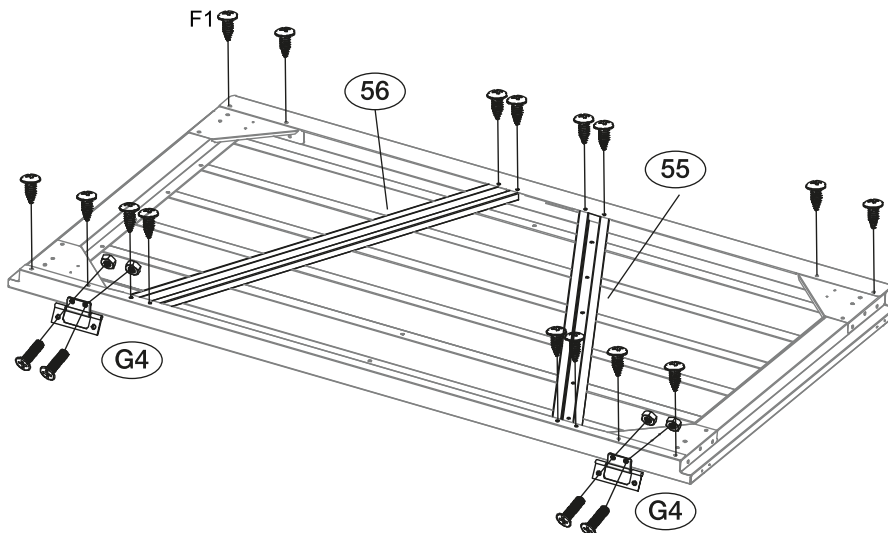
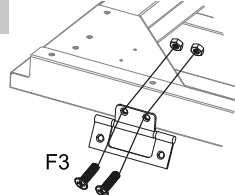

# C-05

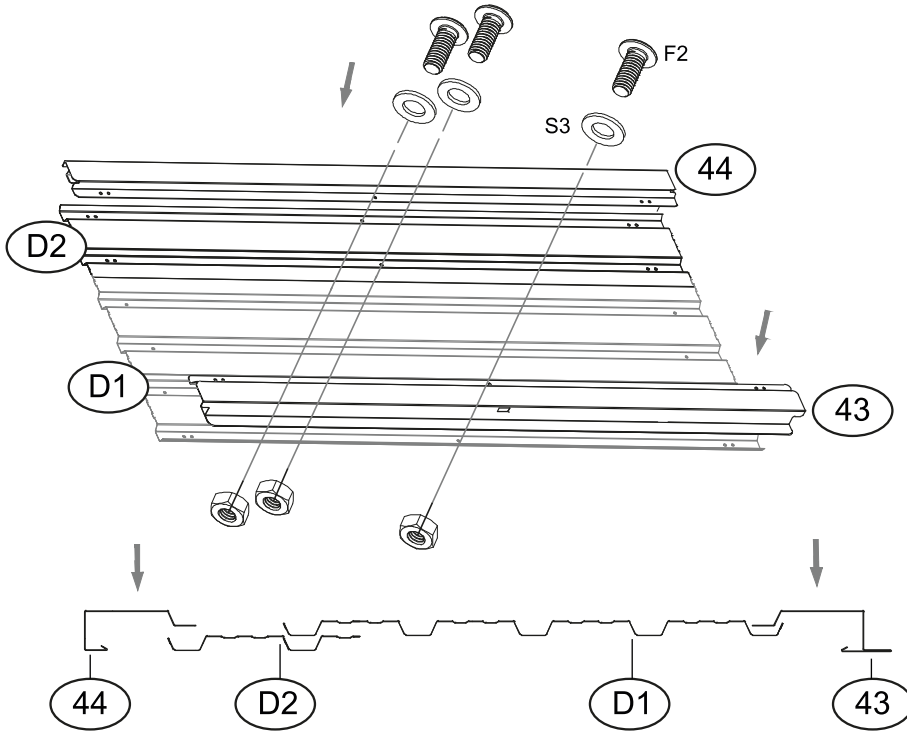
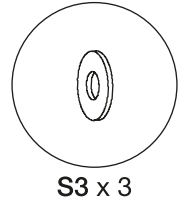
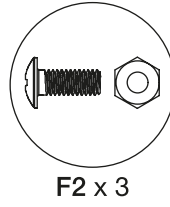
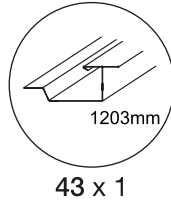
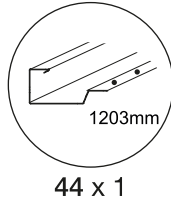
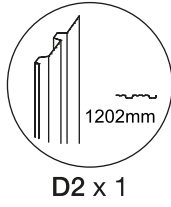
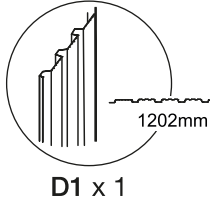

# C-06

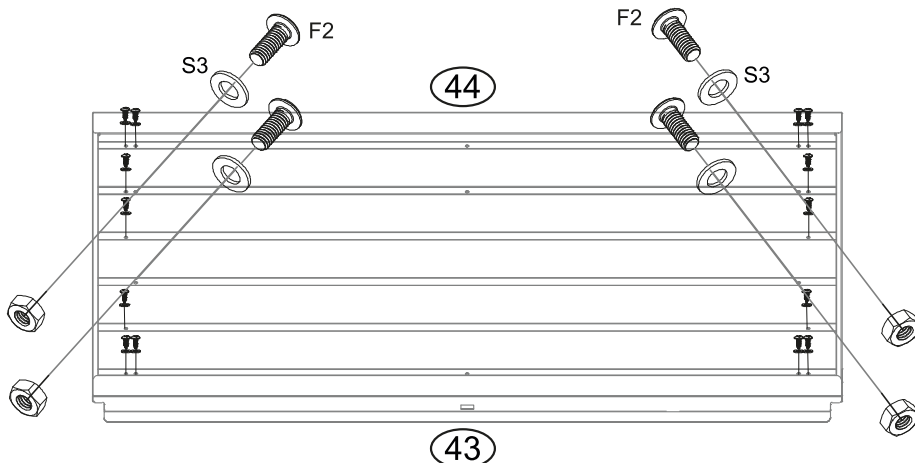
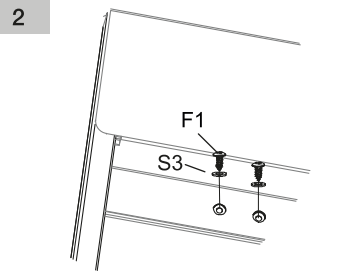
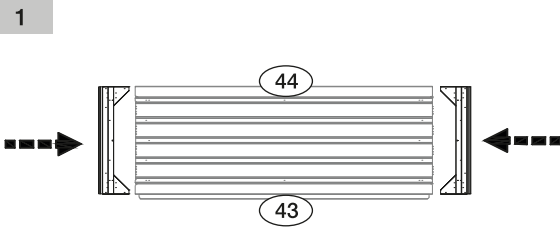
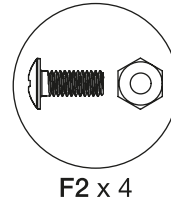
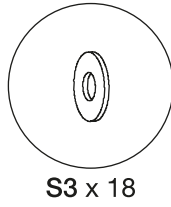
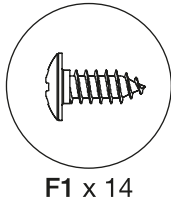

C-07

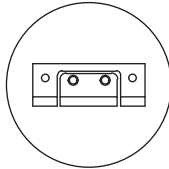

G4 x 2

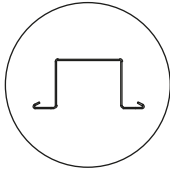

55 x 1

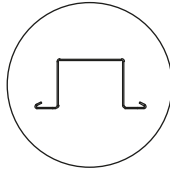

56 x 1

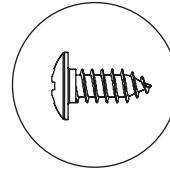

F1 x 16

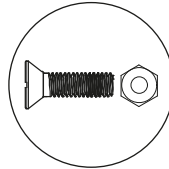

F3 x 4

1

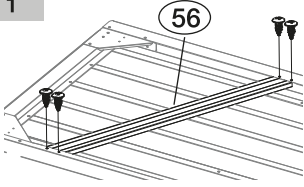

2

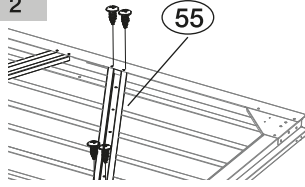

3

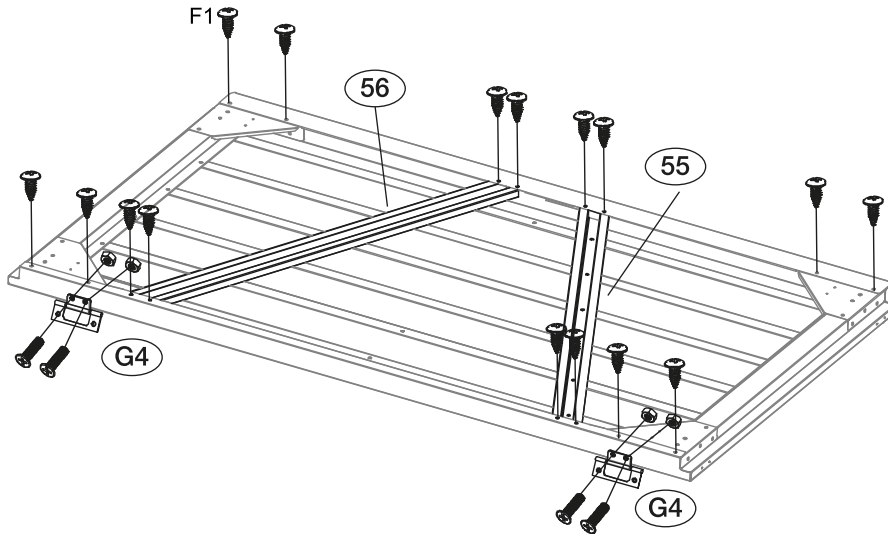
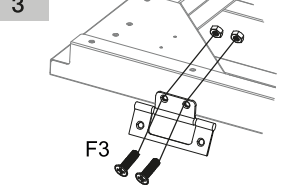

C-08

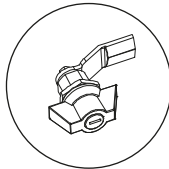

B1 x 1

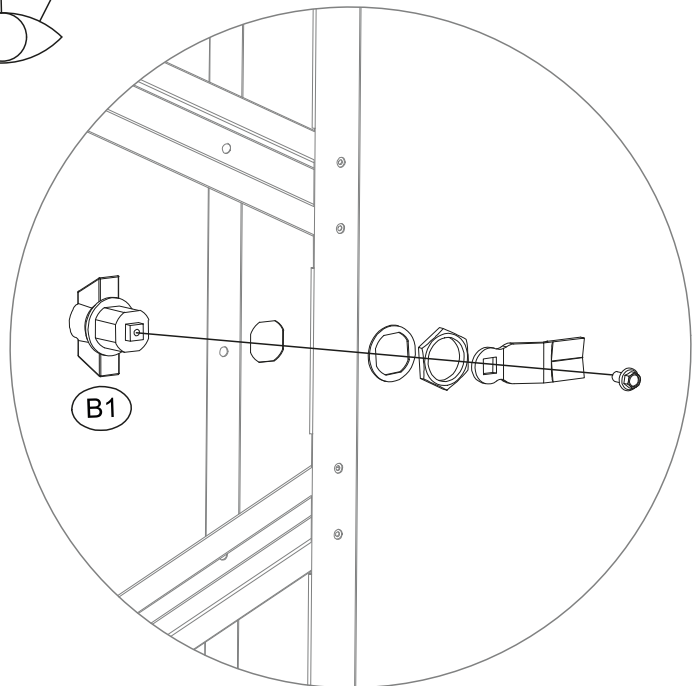
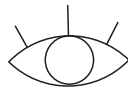
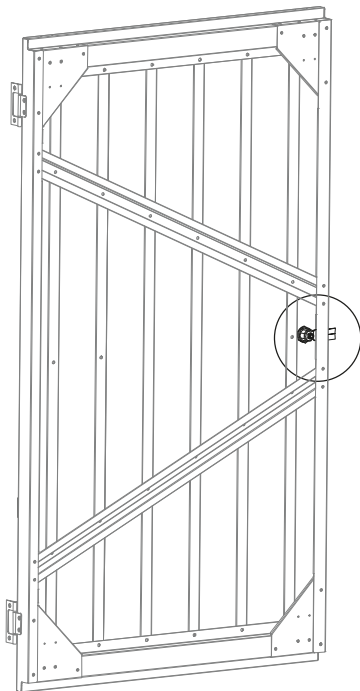

C-09

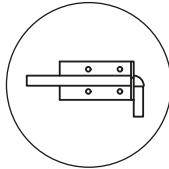

G6 x 2

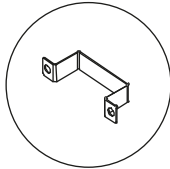

65 x 1

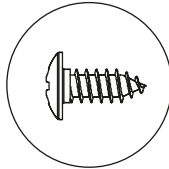

F1 x 10

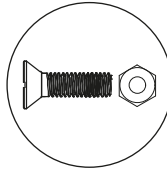

F3 x 8

